

©
MACKIE

1604-VLZ PRO 16-CHANNEL MIC/LINE MIXER OWNER'S MANUAL

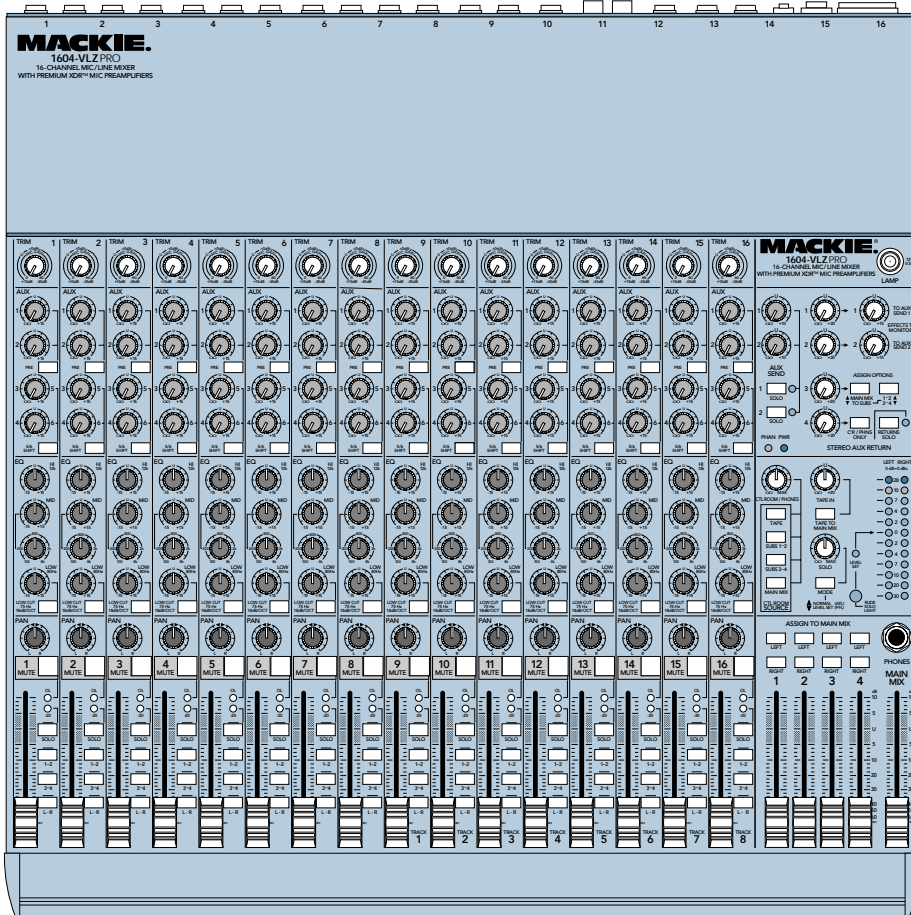

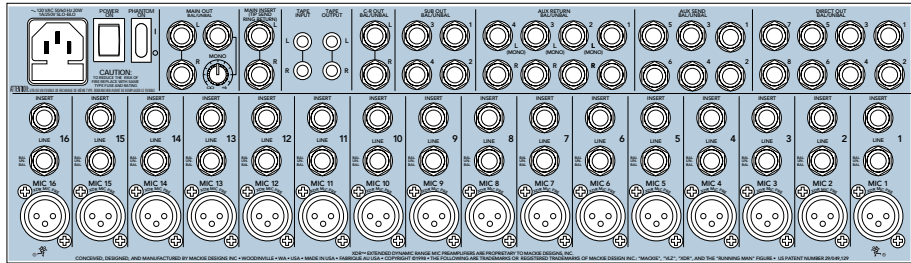

The lightning flash with arrowhead symbol within an equilateral triangle is intended to alert the user to the presence of uninsulated "dangerous voltage" within the product's enclosure, that may be of sufficient magnitude to constitute a risk of electric shock to persons.
 Le symbole éclair avec point de flèche à l'intérieur d'un triangle équilatéral est utilisé pour alerter l'utilisateur de la présence à l'intérieur du coffret de "voltage dangereux" non isolé d'ampleur suffisante pour constituer un risque d'électrocution.



The exclamation point within an equilateral triangle is intended to alert the user of the presence of important operating and maintenance (servicing) instructions in the literature accompanying the appliance.
 Le point d'exclamation à l'intérieur d'un triangle équilatéral est employé pour alerter les utilisateurs de la présence d'instructions importantes pour le fonctionnement et l'entretien (service) dans le livret d'instruction accompagnant l'appareil.

SAFETY INSTRUCTIONS

- 1. Read Instructions** — All the safety and operation instructions should be read before this Mackie product is operated.
- 2. Retain Instructions** — The safety and operating instructions should be kept for future reference.
- 3. Heed Warnings** — All warnings on this Mackie product and in these operating instructions should be followed.
- 4. Follow Instructions** — All operating and other instructions should be followed.
- 5. Water and Moisture** — This Mackie product should not be used near water — for example, near a bathtub, washbowl, kitchen sink, laundry tub, in a wet basement, near a swimming pool, swamp or salivating St. Bernard dog, etc.
- 6. Heat** — This Mackie product should be situated away from heat sources such as radiators, or other devices which produce heat.
- 7. Power Sources** — This Mackie product should be connected to a power supply only of the type described in these operation instructions or as marked on this Mackie product.
- 8. Power Cord Protection** — Power supply cords should be routed so that they are not likely to be walked upon or pinched by items placed upon or against them, paying particular attention to cords at plugs, convenience receptacles, and the point where they exit this Mackie product.

9. Object and Liquid Entry — Care should be taken so that objects do not fall into and liquids are not spilled into the inside of this Mackie product.

10. Damage Requiring Service — This Mackie product should be serviced only by qualified service personnel when:

- The power-supply cord or the plug has been damaged; or
- Objects have fallen, or liquid has spilled into this Mackie product; or
- This Mackie product has been exposed to rain; or
- This Mackie product does not appear to operate normally or exhibits a marked change in performance; or
- This Mackie product has been dropped, or its chassis damaged.

11. Servicing — The user should not attempt to service this Mackie product beyond those means described in this operating manual. All other servicing should be referred to the Mackie Service Department.

12. To prevent electric shock, do not use this polarized plug with an extension cord, receptacle or other outlet unless the blades can be fully inserted to prevent blade exposure.

Pour prévenir les chocs électriques ne pas utiliser cette fiche polarisée avec un prolongateur, un prise de courant ou une autre sortie de courant, sauf si les lames peuvent être insérées à fond sans laisser aucune partie à découvert.

13. Grounding or Polarization — Precautions should be taken so that the grounding or polarization means of this Mackie product is not defeated.

14. This apparatus does not exceed the Class A/Class B (whichever is applicable) limits for radio noise emissions from digital apparatus as set out in the radio interference regulations of the Canadian Department of Communications.

ATTENTION — Le présent appareil numérique n'émet pas de bruits radioélectriques dépassant les limites applicables aux appareils numériques de class A/de class B (selon le cas) prescrites dans le règlement sur le brouillage radioélectrique édicté par les ministere des communications du Canada.

15. To prevent hazard or damage, ensure that only microphone cables and microphones designed to IEC 268-15A are connected.

WARNING — To reduce the risk of fire or electric shock, do not expose this appliance to rain or moisture.

READ THIS PAGE!!!

We realize that you must have a powerful hankerin' to try out your new 1604-VLZ PRO. Or you might be one of those people who never reads manuals. Either way, all we ask is that you read this page NOW, and the rest can wait until you're good and ready. But do read it — you'll be glad you did.

1 LEVEL-SETTING PROCEDURE

Message to seasoned pros: *do NOT* set levels using the old "Turn the trim up until the clip light comes on, then back off a hair" trick. When a Mackie Designs mixer clip light comes on, you really are about to clip.

This procedure really works — it assures low noise and high headroom. Please read on.

It's not even necessary to hear what you're doing to set optimal levels. But if you'd like to: Plug headphones into the PHONES output jack, then set the C-R PHONES knob about one-quarter of the way up.

The following steps must be performed *one channel at a time*:

1. Turn the TRIM, AUX send and fader controls fully down.
2. Be sure the 1-2, 3-4 and L-R channel assignment switches are all disengaged.
3. Set the EQ knobs at the center detents.
4. Connect the signal source to the MIC or LINE channel input.
5. Engage (push in) the channel's SOLO switch.
6. Push in the MODE switch in the output section (LEVEL SET (PFL) mode) — the LEVEL SET LED will light.
7. Play something into the selected input, at real-world levels.
8. Adjust the TRIM control so that the display on the meter stays around "0." (Only the left meter is active in the Level-Setting Procedure.)
9. If you'd like to apply some EQ, do so now and return to the previous step.
10. Disengage that channel's SOLO switch.
11. Repeat for each of channels 1-16.

Other Nuggets of Wisdom

For optimum sonic performance, the channel faders and the MAIN MIX fader should be set near the "U" (unity gain) markings.

Always turn the MAIN MIX fader and CTL ROOM/PHONES knob down before making connections to and from your 1604-VLZ PRO.

If you shut down your equipment, turn off your amplifiers first. When powering up, turn on your amplifiers last.

Save the shipping box! You may need it someday, and you don't want to have to pay for another one.



2 INSTANT MIXING

Here's how to get going right away, assuming you own a microphone and a keyboard:

1. Plug your microphone into Channel 1's MIC input.
2. Turn on the 1604-VLZ PRO.
3. Perform the **Level-Setting Procedure 1**.
4. Connect cords from the MAIN OUT jacks to your amplifier.
5. Hook up speakers to the amp and turn it on.
6. Set channel 1's fader to the "U" mark.
7. Engage (push in) Channel 1's L-R switch.
8. Set the MAIN MIX fader one-quarter of the way up.
9. Sing like a canary!
10. Plug your keyboard into channels 3 and 4.
11. Turn channel 3's PAN knob fully left and channel 4's PAN knob fully right.
12. Set those faders to the "U" mark.
13. Perform the **Level-Setting Procedure 1**.
14. Engage the L-R switch on these channels.
15. Play like a madman *and* sing like a canary!
It's your first mix!

Please write your serial number here for future reference (i.e. insurance claims, tech support, return authorization, etc.):

Purchased at:

Date of purchase:

INTRODUCTION

Thank you for choosing a Mackie Designs professional compact mixer. The 1604-VLZ PRO is equipped with our new precision-engineered XDR™ Extended Dynamic Range premium studio-grade mic preamp featuring:

- Full gain range from 0 to 60dB
- +22 dBu line signal handling capability
- 130 dB dynamic range
- Distortion less than 0.005%, 20Hz to 20kHz
- Bullet-proof RF rejection using DC pulse transformer circuitry
- Made in Woodinville, Washington, USA

Now that you have your 1604-VLZ PRO, find out how to get the most from it. That's where this manual comes in.

HOW TO USE THIS MANUAL

Since many of you folks will want to hook up your 1604-VLZ PRO immediately, the first pages you will encounter after the table of contents are the ever popular hookup diagrams. These show typical mixer setups for Record/Mixdown, Video, Disc Jockey and Stereo PA. After this section is a detailed tour of the entire mixer.

Every feature of the 1604-VLZ PRO will be described “geographically;” in other words, in order of where it is physically placed on the mixer’s top or rear panel. These descriptions are divided into the first three manual chapters, just as your mixer is organized into three distinct zones:

1. PATCHBAY: The zillion jacks on the back of the “pod.”
2. CHANNEL STRIP: The sixteen channel strips on the left.
3. OUTPUT SECTION: The output section on the right.

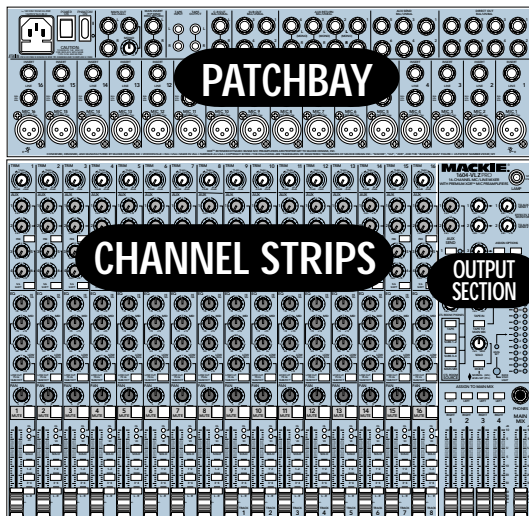

Whenever a specific 1604-VLZ PRO component is mentioned, it'll be in all capital letters sans-serif type. That can help you find references to specific controls much faster, without slowing you down as you read normally. For example: The quick brown fader jumped over the RUDE SOLO LIGHT.

Throughout these chapters you'll find illustrations, with each feature numbered. If you're curious about a feature, simply locate it on the appropriate illustration, note the number attached to it, and find that number in the nearby paragraphs or refer to the table of contents.

You'll also find cross-references to these numbered features within a paragraph. For instance, if you see “*To wire your own cables:* 12,” simply find that number in the manual and you've found your answer. (These are not page numbers.)

You'll also notice feature numbers just floating in space, like this 33. These numbers direct you to relevant information.



This icon marks information that is critically important or unique to the 1604-VLZ PRO. For your own good, read them and remember them. They will be on the final test.



This icon will lead you to in-depth explanations of features and practical tips. While not mandatory, they'll have some valuable information.

THE GLOSSARY: A HAVEN OF NON-TECHINESS FOR THE NEOPHYTE

Appendix A is a fairly comprehensive dictionary of pro-audio terms. If terms like “clipping,” “noise floor,” or “unbalanced” leave you blank, flip to this glossary for a quick explanation.

A PLUG FOR THE CONNECTORS SECTION

Appendix B is a section on connectors: XLR connectors, balanced connectors, unbalanced connectors, special hybrid connectors.

ARCANE MYSTERIES ILLUMINATED

Appendix C discusses some of the down 'n' dirty practical realities of microphones, fixed installations, grounding, and balanced versus unbalanced lines. It's a goldmine for the neophyte and even the seasoned pro might learn a thing or two.

CONTENTS

1	LEVEL-SETTING PROCEDURE	3
2	INSTANT MIXING	3
3	HOOKUP DIAGRAMS	6
4	CONVERTING TO RACKMOUNT MODE	9
6	PATCHBAY DESCRIPTION	10
7	E-Z INTERFACE	10
8	MIC/LINE INPUTS ON EVERY CHANNEL	10
9	MIC INPUTS	10
11	PHANTOM POWER	10
12	LINE INPUTS	11
13	TRIM	11
14	INSERT	11
15	DIRECT OUT	11
16	SPLIT MONITORING	12
17	AUX SEND OUTPUTS	12
18	EFFECTS: SERIAL OR PARALLEL?	13
19	AUX RETURN INPUTS	13
21	SUB OUTS	13
22	C-R OUTS (CONTROL ROOM OUTPUTS)	14
23	PHONES OUTPUT	14
24	TAPE OUTPUT	14
25	TAPE INPUT	14
26	MAIN INSERT	15
27	MAIN OUTS	15
28	MONO OUTPUT	15
29	MONO LEVEL	15
31	POWER CONNECTION	15
32	FUSE	15
33	POWER SWITCH	16
34	POWER LED	16
35	PHANTOM SWITCH	16
36	PHANTOM LED	16
37	BNC LAMP SOCKET	16
38	CHANNEL STRIP DESCRIPTION	17
39	“U” LIKE UNITY GAIN	17
40	FADER	17
41	ASSIGN (1-2, 3-4, L-R)	17
42	SOLO	18
43	-20 (SOLO) LED	18
44	OL (MUTE) LED	18
45	MUTE	19
46	PAN	19
47	3-BAND MID-SWEEP EQ	19
48	LOW CUT	20
49	AUX	20
51	PRE	21
52	5/6 SHIFT	21
53	OUTPUT SECTION DESCRIPTION	22
54	MAIN MIX FADER	22
55	VLZ MIX ARCHITECTURE	22
56	SUB FADERS	22
57	ASSIGN TO MAIN MIX	22
58	TAPE IN (LEVEL)	23
59	TAPE TO MAIN MIX	23
61	SOURCE	23
62	CTL ROOM/PHONES	23
63	MODE (NORMAL (AFL)/LEVEL SET (PFL))	24
64	LEVEL SET LED	24
65	SOLO (LEVEL)	24
66	RUDE SOLO LIGHT	24
67	METERS	25
68	AUX TALK	25
69	AUX SEND (MASTER)	25
71	AUX SEND SOLO	26
72	AUX RETURNS (LEVEL)	26
73	EFFECTS TO MONITOR	26
74	MAIN MIX TO SUBS (AUX RET 3)	26
75	1-2/3-4 (AUX RET 3)	26
76	C-R/PHNS ONLY (AUX RET 4)	27
77	RETURNS SOLO	27
78	1604-VLZ PRO MODIFICATIONS	28
79	1604-VLZ PRO BLOCK DIAGRAM	30
80	GAIN STRUCTURE DIAGRAM	31
81	SPECIFICATIONS	32
82	SERVICE INFO	33
A	APPENDIX: Glossary	34
B	APPENDIX: Connections	42
C	APPENDIX: Balanced Lines, Phantom Powering, Grounding and Other Arcane Mysteries	46

3 HOOKUP DIAGRAMS

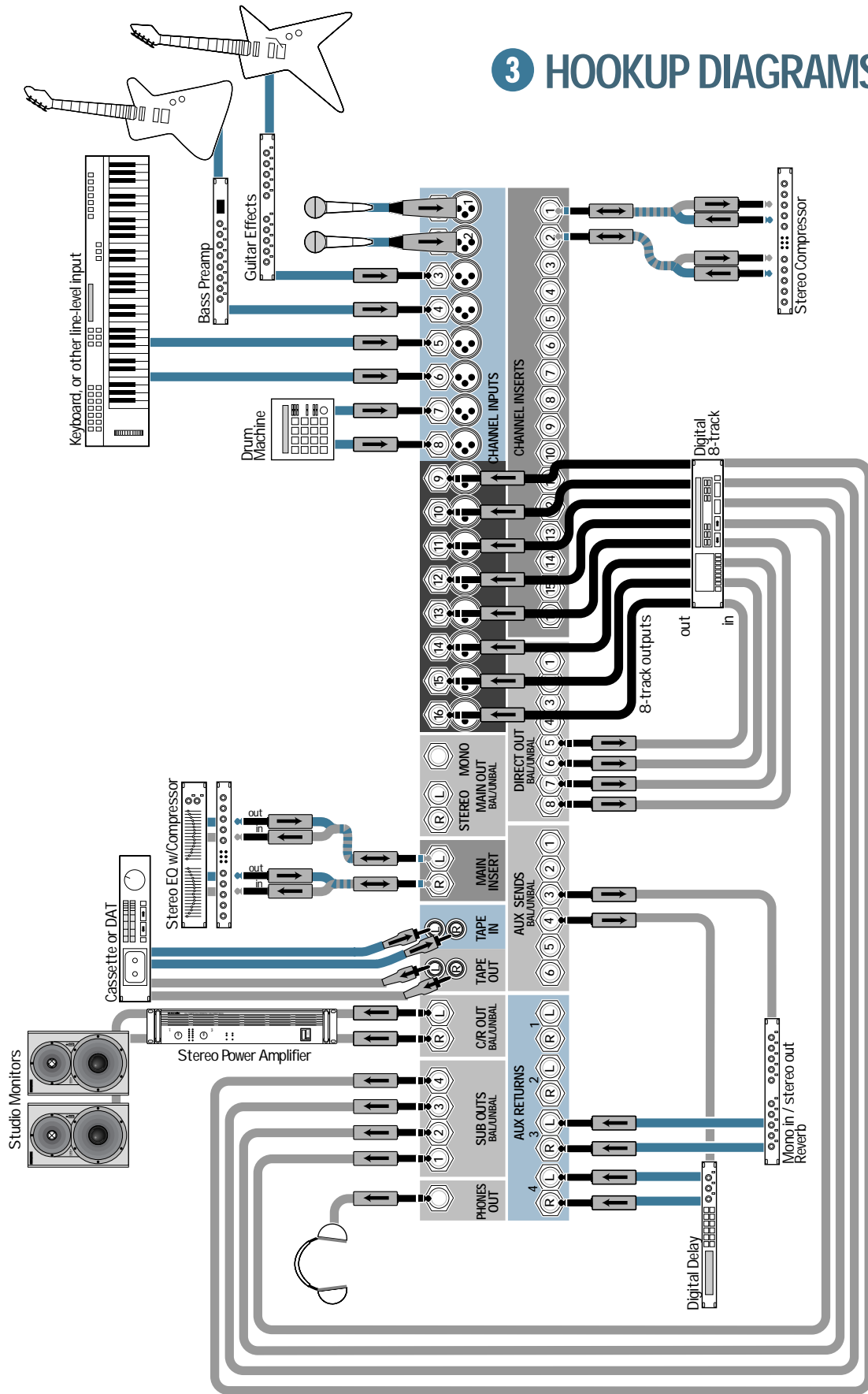

1604-VLZ PRO 8-Track Tracking

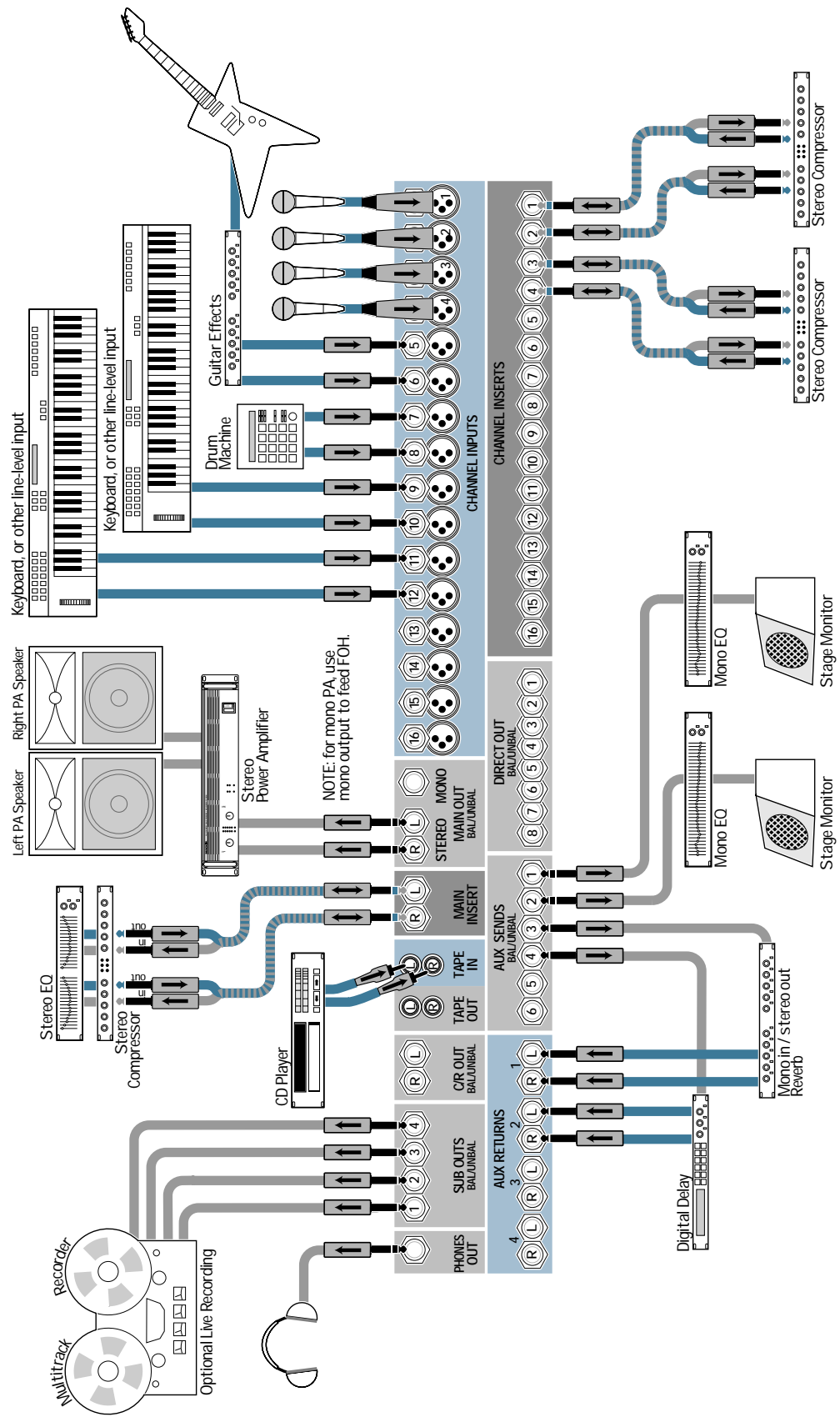

1604-VLZ PRO Stereo P.A.

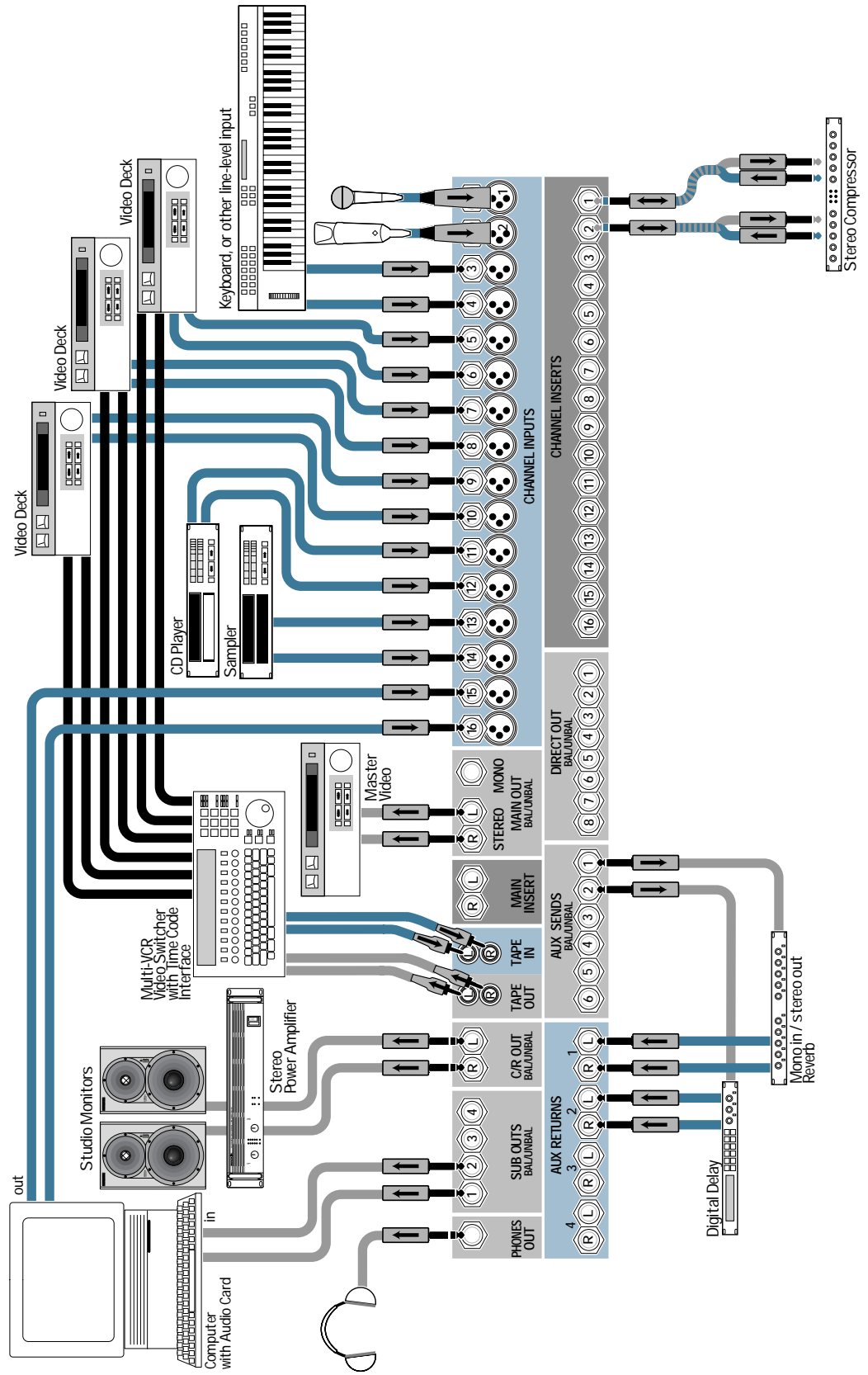

1604-VLZ PRO Video Setup

4 CONVERTING TO RACKMOUNT MODE

Not only is the new 1604-VLZ PRO a compact, professional-quality tabletop mixer, it's rack-mountable! Its unique rotating input pod makes this possible.

One of the things that revolutionized the compact mixer industry was the “convertible pod” found on the original, classic CR-1604. Using an ordinary Phillips screwdriver, the mixer could be converted from desktop mode (as it comes from the factory) to rackmount mode.

Fear not. We wouldn't dare take that feature out of the New Improved 1604-VLZ PRO. It's still there and still takes just a few minutes with your trusty screwdriver. Here's how it's done:

1. Remove ALL the cords from the mixer — audio, power, lamps, everything.
2. Place the mixer, face down, on a clean soft surface, like a blanket or very large dog.
3. Remove the four screws securing the cable cover **a** and set the plate aside.
4. Replace two of the screws; the ones at the pod end of the mixer **b**.
5. Remove two pod-mounting screws on each side of the mixer **c**.
6. Gently pull the pod away from the slots, rotate it, and place it, tabs first, into the rackmount tabs **d**, located on the underside of the main chassis. Be careful not to constrict or pinch any of the ribbon or power cables.
7. Carefully install the pod-mounting screws in their new locations **d**.
8. Install the rack ears that came with the mixer. They can be installed in either of two depths: **e** mixer's surface flush with the rack rails, like ordinary rackmount equipment, or **f** mixer's surface sunken into the rack, to protect the knobs from being bumped.

An optional accessory called the ROTOPOD-VLZ is available and can be used in desktop or rackmount installations. It will put the patchbay jacks on the same plane as all the knobs, buttons and faders. This is a lifesaver in applications that demand frequent repatching, and costs a heck of a lot less than an external patchbay, not to mention all the interface and patch cords: [82](#). Please visit your dealer for more exciting details. Be sure to order the “VLZ” version so you don't end up with the one for the classic CR-1604!

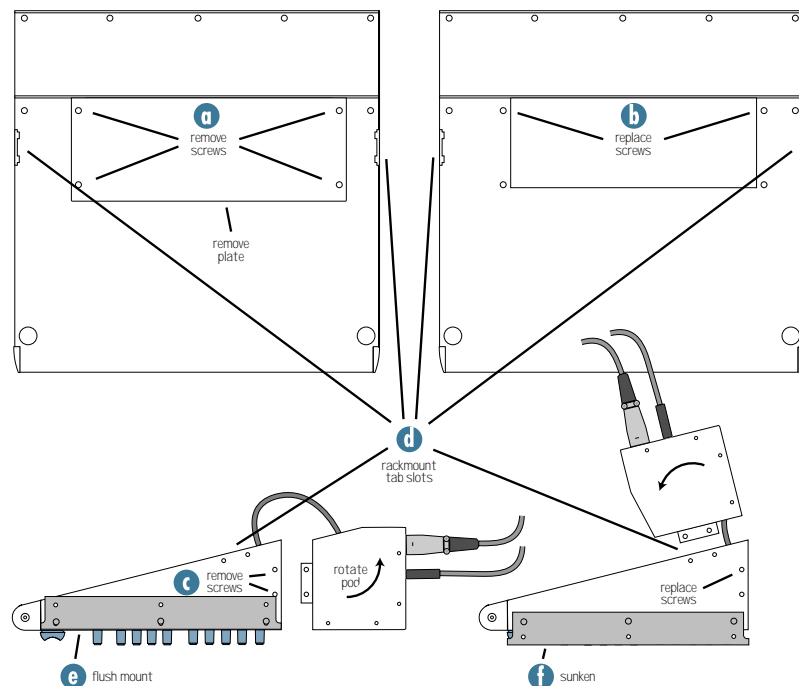

6 PATCHBAY DESCRIPTION

At the risk of stating the obvious, this is where you plug everything in: microphones, line-level instruments and effects, and the ultimate destination for your sound: a tape recorder, PA system, etc. A few of the features described in this section are on top of the mixer, but most are out back on the “pod.”



7 E-Z INTERFACE

Concerned about levels, balancing, impedances, polarity, or other interface goblins? Don't be. On your 1604-VLZ PRO, you can patch anything almost anywhere, with nary a care. Here's why:

- Every input and output is balanced (except insert, phones and RCA jacks).
- Every input and output will also accept unbalanced lines (except XLR jacks).
- Every input is designed to accept virtually any output impedance.
- The main left and right mix outputs can deliver 28dBu into as low as a 600 ohm load.
- All the other outputs can deliver 22dBu into as low as a 600 ohm load.
- All the outputs are in phase with the inputs.

All we ask is that you perform the **Level-Setting Procedure 1** every time you patch in a new sound source. So stop worrying and start mixing!

8 MIC/LINE INPUTS ON EVERY CHANNEL

The original CR-1604 had six mic/line channels and ten line-only channels. That was fine for most applications, but live sound users were forced to go out and buy the XLR-10 mic input add-on module. No more. Each and every channel on the New Improved 1604-VLZ PRO has the legendary Mackie mic/line input circuit. It's like getting a free XLR-10 with your mixer!

9 MIC INPUTS

We use phantom-powered, balanced microphone inputs just like the big studio mega- consoles, for exactly the same reason: This kind of circuit is excellent at rejecting hum

and noise. You can plug in almost any kind of mic that has a standard XLR-type male mic connector. Always be sure to perform the **Level-Setting Procedure 1**. To learn how signals are routed from these inputs: 38. If you wire your own, connect them like this:

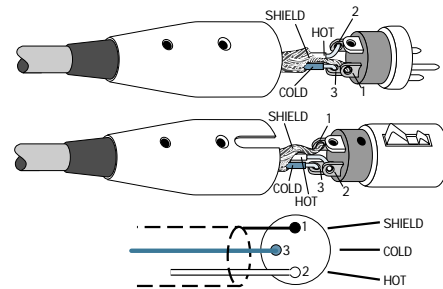

- Pin 1 = ground or shield**
- Pin 2 = positive (+ or hot)**
- Pin 3 = negative (- or cold)**

Professional ribbon, dynamic, and condenser mics will all sound excellent through these inputs. The 1604-VLZ PRO's mic inputs will handle almost any kind of mic level you can toss at them, without overloading.

11 PHANTOM POWER

Most condenser mics require phantom power, where the mixer sends low-current DC voltage to the mic's electronics through the same wires that carry audio. The 1604-VLZ PRO's phantom power is globally controlled by the PHANTOM switch on the rear panel 35.

Semipro condenser mics often have batteries to accomplish the same thing. “Phantom” owes its name to an ability to be “unseen” by dynamic mics (Shure® SM57/SM58, for instance) that don't need external power and aren't affected by it anyway.



Unless you know for certain it is safe to do so, never plug single-ended (unbalanced) microphones, instruments or electronic devices into the MIC input jacks if the phantom power is on.

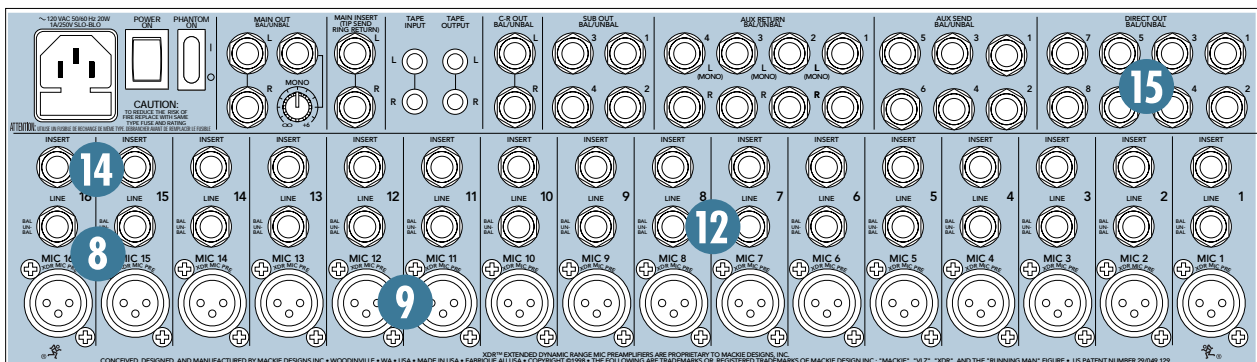

12 LINE INPUTS

These 1/4" jacks share circuitry (but not phantom power) with the mic preamps. You can use these inputs for virtually any signal you'll come across, from instrument levels as low as -50dB to operating levels of -10dBV to +4dBu, as there is 60dB of gain available via the TRIM knob 13. Always be sure to perform the **Level-Setting Procedure** 1.

To learn how signals are routed from these inputs: 38. To connect balanced lines to these inputs, use a 1/4" tip-ring-sleeve (TRS) plug, the type found on some stereo headphones:

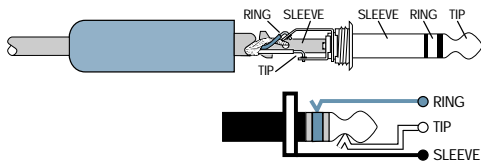

Tip = positive (+ or hot)
Ring = negative (- or cold)
Sleeve = shield or ground

To connect unbalanced lines to these inputs, use a 1/4" mono (TS) phone plug or standard instrument cable:

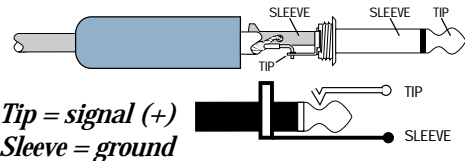

Tip = signal (+)
Sleeve = ground

13 TRIM

Yes it's true, these controls are not located in the patchbay section at all. They're found along the top row of knobs in the channel strip section. But their purpose is so closely linked with the MIC and LINE input jacks that we couldn't bear to separate them. Here's why: Every time you plug something into a MIC or LINE input jack, you should perform the **Level-Setting Procedure** 1, and that procedure is basically "how to use the TRIM knob."

TRIM adjusts the input sensitivity of the MIC and LINE inputs. This allows signals from the outside world to be adjusted to optimal internal operating levels.

Through the XLR jack (MIC), there will be 0dB of gain with the knob fully down, ramping to 60dB of gain fully up.

Through the 1/4" input (LINE), there is 15dB of attenuation fully down and 45dB of gain fully up, with a "U" (unity gain) mark at 10:00.

This 15dB of attenuation can be very handy when you are inserting a signal that is very hot, or you want to add a lot of EQ gain, or both. Without this "virtual pad," a scenario like that might lead to channel clipping.

14 INSERT

These 1/4" jacks are for connecting serial effects processors such as compressors, equalizers, de-essers, or filters 18. The INSERT point is after the TRIM control, but before the channel's EQ, LOW CUT, fader and MUTE controls. Insert cables must be wired thusly:

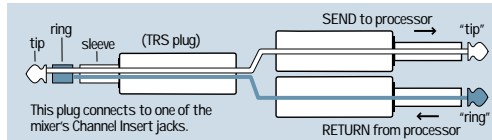

Tip = send (output to effects device)
Ring = return (input from effects device)
Sleeve = common ground

Even though channels 1-8 already have DIRECT OUT jacks 15, INSERT jacks can also be used as channel direct outputs; post-TRIM, pre-LOW CUT, and pre-EQ. Here's three ways you can use the INSERT jacks:

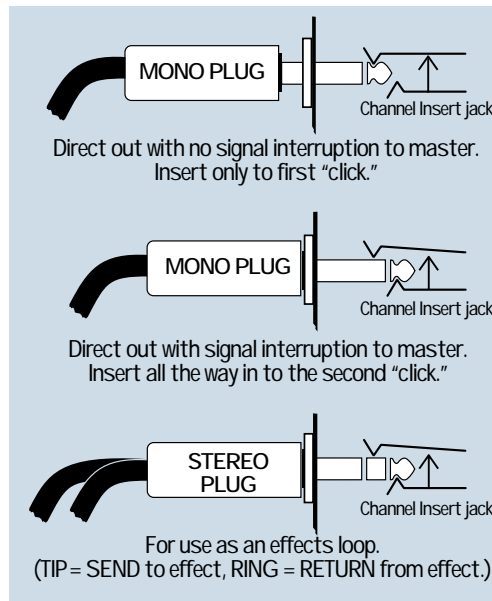

15 DIRECT OUT

Found only on channels 1-8, these 1/4" jacks deliver the signal from the very end of the channel path; post-TRIM, post-EQ, post-LOW CUT, post-fader and post-MUTE. They are the key player in "split monitoring," making the 1604-VLZ PRO perfect for an 8-track studio. **To wire your own cables:** 27.

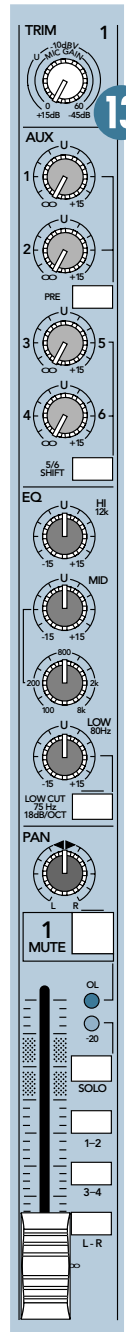

16 SPLIT MONITORING

With split monitoring, you use the first eight channels for your sound sources: vocal mics, drum mics, keyboard/synth outputs, guitar effects outputs, that sort of thing. From there, the channels manipulate the sound, but are not assigned to the output section. Instead, they're patched from the channel's DIRECT OUT jacks to the corresponding multitrack input (DIRECT OUT 1 to multitrack input 1, 2 to 2, 3 to 3, etc.). The signals will now be recorded or pass directly through the multitrack, depending on each track's record-ready status.

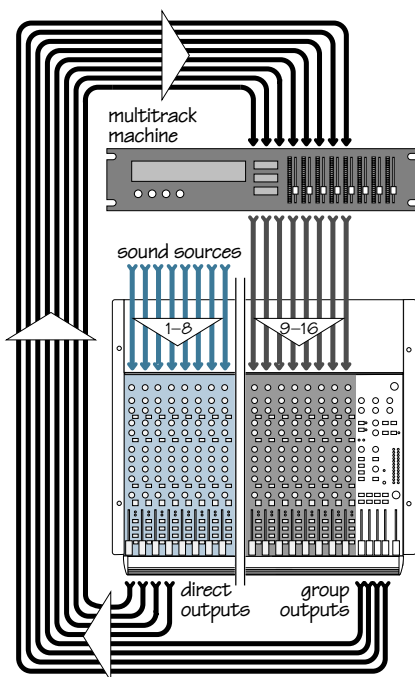

The outputs of the multitrack are then patched to the next eight LINE inputs on the 1604-VLZ PRO (multitrack out 1 to LINE input 9, 2 to 10, 3 to 11, etc.). Aha! That's why it says "TRACK 1" next to channel 9's fader, "TRACK 2" next to channel 10, and so forth. These channels (9–16) will be assigned to the mixer's output section, delivering the signals to their ultimate destination, which may be your mixdown 2-track, your control room system, or your headphones.

But let's not forget that the 1604-VLZ PRO is a 4-bus mixer. These buses lead to the SUB OUTS 21, and are designed to accomplish the task of getting channels to the multitrack without using the direct outputs.

For example, a channel is assigned to SUB OUT 1. SUB OUT 1's output is patched to multitrack input 1. From there, the multitrack output goes to the mixer's channel 9 LINE input, as we just discussed. (Hot tip: To feed an 8-track deck with 4 sub outputs, simply use Y-cords: SUB OUT 1 feeds tracks 1 and 5, 2 feeds 2 and 6, 3 feeds 3 and 7, and 4 feeds 4 and 8. Tracks in record mode will accept the signal, and tracks in safe mode will ignore the signal.)

The advantages: You can assign any channel to any track, without repatching. You can assign multiple channels to one track and control the overall level of that subgroup 56. You can't bounce tracks without this feature.

Perhaps the best method is to do both: Use the SUB OUTS to feed multichannel submixes (like a drum kit) to some of the tracks, and the DIRECT OUT jacks to feed single-channel signals (like bass guitar) to the other tracks.

The point is that you never listen directly to the source channels (1–8). You listen to the monitor channels (9–16) and they're listening to the multitrack that is listening to the source channels. The main advantage is that you won't be forced to constantly repatch your multitrack — just set it up and forget it. You'll also know for certain that the signals are indeed getting to the multitrack, since you're constantly listening to it.

Another method of interfacing a multitrack is called inline monitoring, and requires a mixing console dedicated to that, like the Mackie 8•Bus. Each of its channels is actually two channels: one carrying the mic/line sound source and the other carrying the multitrack output.

17 AUX SEND OUTPUTS

These 1/4" jacks usually patch to the inputs of your parallel effects devices 18 or to the inputs of your stage monitor amps. To learn how signals are routed to these outputs: 68. **To wire your own cables:** 27.

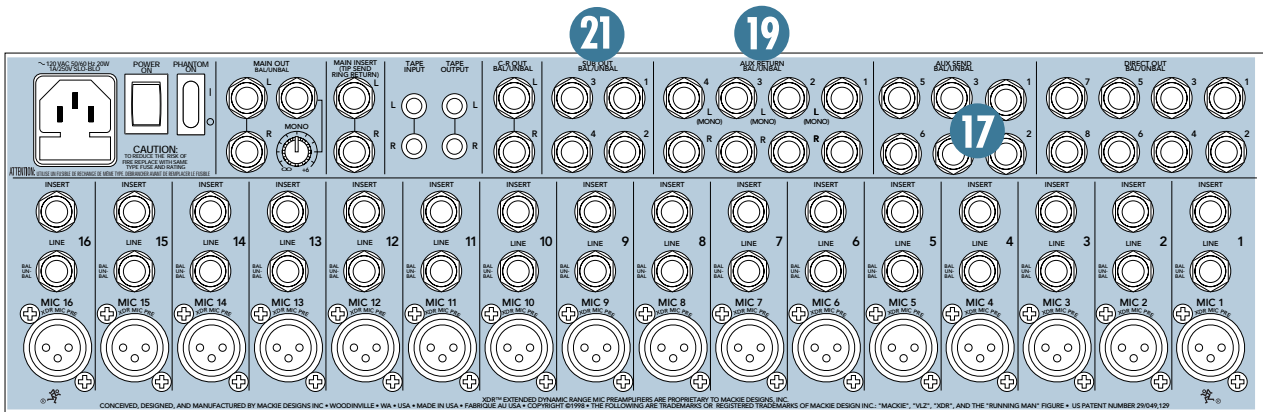

18 EFFECTS: SERIAL OR PARALLEL?

You've heard us carelessly toss around the terms "serial" and "parallel." Here's what we mean by them:

"Serial" means that the *entire* signal leaves the mixer (INSERT send), is routed through the effects device, and returns to the mixer (INSERT return). Examples: compressor, limiter, graphic equalizer. Line-level sources can also be patched through a serial effects device before or after the mixer.

"Parallel" means that a *portion* of the signal in the mixer is tapped off to the device (AUX SEND), processed, and returned to the mixer (AUX RETURN) to be mixed with the original "dry" signal. This way, multiple channels can all make use of the same effects device. Examples: reverb, digital delay.

19 AUX RETURN INPUTS

This is where you connect the outputs of your parallel effects devices (or extra audio sources). They'll accept just about any pro or semipro effects device on the market. *To learn how signals are routed from these inputs: 12. To wire your own cables: 12.*

Mono: If you have an effects device with a mono output (one cord), plug that into L input of an AUX RETURN and leave the right input unplugged. That way, the signal will be sent to both sides, magically appearing in the center as a mono signal.

21 SUB OUTS

These 1/4" jacks are usually patched to the inputs of a multitrack deck, or to secondary amplifiers in a complex installation. *To learn how signals are routed to these outputs: 56. To wire your own cables: 27.*

Double Busing

How on earth do you get four jacks to feed eight tracks? To feed an 8-track deck with only four SUB OUTS, simply use four Y-cords:

- SUB OUT 1 feeds tracks 1 and 5
- SUB OUT 2 feeds tracks 2 and 6
- SUB OUT 3 feeds tracks 3 and 7
- SUB OUT 4 feeds tracks 4 and 8

Tracks in record mode will accept the signal, and tracks in safe mode will ignore the signal. It's that easy.

Serial Device (e.g., Compressor)

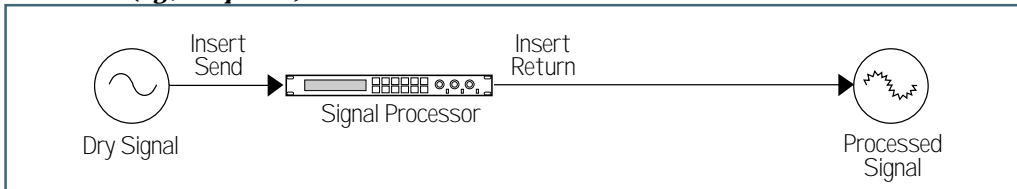

Parallel Device (e.g., Reverb)

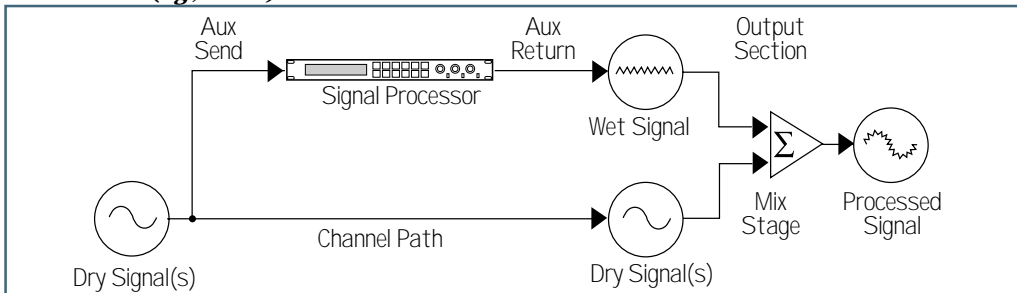



This method is exactly the same as the double-busing feature found in other mixers. Built-in double-busing is nothing more than Y-cords living inside the mixer instead of hanging out the back. If we had room for the extra jacks, we would have thrown them in, but we don't, so we didn't. Sonically, there is no difference whatsoever.

Y-cord advice: Do **not** use the stereo "headphone-to-left/right" splitter adapters. Use the type that send the same signal to two places; the tip of the source plug feeds the tips of both destination plugs (Radio Shack® #42-2150, for instance.)

22 C-R OUTS (CONTROL ROOM OUTPUTS)

These 1/4" jacks are usually patched to the inputs of your control room amplifier or a headphone distribution amplifier. *To learn how signals are routed to these outputs:* 62. *To wire your own cables:* 27.

23 PHONES OUTPUT

The 1604-VLZ PRO's stereo 1/4" phones jack will drive any standard headphone to very loud levels. Walkperson-type phones can also be used with an appropriate adapter. *To learn how signals are routed to these outputs:* 62. If you're wiring your own cable for the PHONES output, follow standard conventions:

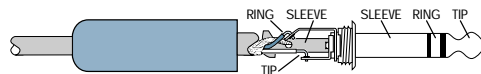

Tip = left channel
Ring = right channel
Sleeve = common ground

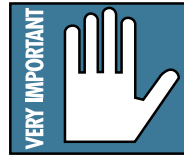
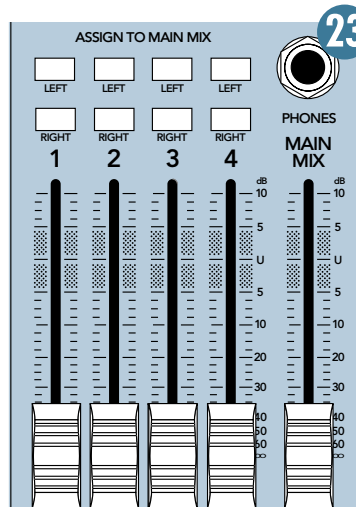

WARNING: When we say *the headphone amp is loud, we're not kidding. It can cause permanent ear damage. Even intermediate levels may be painfully loud with some earphones. BE CAREFUL!*

Always turn the CTL ROOM/PHONES knob all the way down before connecting headphones. Keep it down until you've put the phones on. Then turn it up slowly. Why? *"Engineers who fry their ears find themselves with short careers."*

24 TAPE OUTPUT

These unbalanced RCA jacks tap the MAIN MIX outputs to make simultaneous recording and PA work more convenient. Connect these to your 2-track recorder's inputs. *To learn how signals are routed to these outputs:* 54.

Mono: If you want to feed a mono signal to your tape deck or other device, simply use the 1/4" MONO output jack 28. Alternatively, use an RCA Y-cord to combine the TAPE OUTPUT jacks (Radio Shack® #274-511, for instance). Do not attempt this with any other outputs on the 1604-VLZ PRO.

25 TAPE INPUT

These unbalanced RCA jacks are designed to work with semipro as well as pro recorders. Connect your 2-track tape recorder's outputs here, using standard hi-fi RCA cables. *To learn how signals are routed from these inputs:* 58.

Use these jacks for convenient playback of your mixes. You'll be able to review a mix, and then rewind and try another pass without repatching or disturbing the mixer levels. You can also use these jacks with a portable tape or CD player to feed music to a PA system between sets 59.



WARNING: Pushing TAPE TO MAIN MIX *in the output section can create a feedback path between TAPE INPUT and TAPE OUTPUT. Make sure your tape deck is not in record, record-pause or input monitor mode when you engage this switch, or make sure the TAPE IN level knob is fully counterclockwise (off).*

26 MAIN INSERT

These 1/4" jacks are for connecting serial effects such as compressors, equalizers, de-essers, or filters 18. The INSERT point is after the mix amps, but before the MAIN MIX fader. Insert cables must be wired thusly:

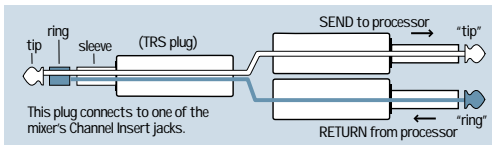

Tip = send (output to effects device)

Ring = return (input from effects device)

Sleeve = common ground (connect shield to all three sleeves)

27 MAIN OUTS

These 1/4" jacks are usually patched to the inputs of your 2-track mixdown deck (unless you've chosen to use the TAPE OUTPUT RCA jacks), or to the house amplifier during live sound sessions. **To learn how signals are routed to these outputs:** 54. To use these outputs to drive balanced inputs, connect 1/4" TRS (Tip-Ring-Sleeve) phone plugs like this:

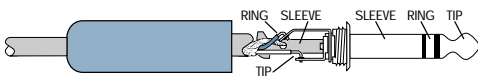

Tip = + (hot)

Ring = - (cold)

Sleeve = ground

To use these outputs to drive unbalanced inputs, connect 1/4" TS (Tip-Sleeve) phone plugs like this:

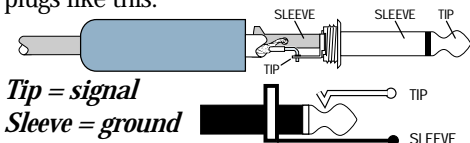

Tip = signal

Sleeve = ground

28 MONO OUTPUT

It happens to everybody sooner or later: The forces that govern your world will demand a monaural output from your painstakingly-created stereo panorama. The last thing you want to do is start twirling all your carefully-placed PAN settings to one side. What to do? Stick a cord in this 1/4" jack, hand the other end to Mr. Mono, and you're done. He's got his mono mix and you've still got your stereo mix. The MONO output is nothing more than a mix of the left and right MAIN MIX.

29 MONO LEVEL

So, Mr. Mono comes running back, screaming about the mono mix being so loud that his camcorder is melting. Just reach for this knob and turn it down a bit. Just the thing for send-

ing mono signals to mic inputs like camcorders, telephone interface boxes, even answering machines. With the pot all the way up (fully clockwise), you'll have 6dB of extra gain with unity gain halfway between the one and two o'clock positions.

31 POWER CONNECTION

Just in case you lose the cord provided with the 1604-VLZ PRO, its power jack accepts a standard 3-prong IEC cord like those found on most professional recorders, musical instruments, and computers. At the other end of our cord is — get this — a plug! Not a black cube or, as we're fond of calling them, a "wall wart." We did this for some very good reasons:

The 1604-VLZ PRO has sophisticated power requirements that a wall wart cannot provide. Wall warts are inconvenient, fragile, radiate huge hum fields, hog extra jacks on your power strip and get in the way. If you lose a wall wart, you're in trouble, but if you lose the 1604-VLZ PRO's power cord, you can get a new one at any electronics, music, or computer store. You can even buy them at Radio Shack® (part # 278-1257).

Plug the 1604-VLZ PRO into any standard grounded (3-pin) AC outlet or into a power strip of proper voltage.

VERY IMPORTANT **WARNING: Disconnecting the plug's ground pin can be dangerous. Please don't do it.**

32 FUSE

The 1604-VLZ PRO is fused for your (and its own) protection. If you suspect a blown fuse, disconnect the power cord, pull the fuse drawer out (located just below the cord receptacle) and replace the fuse with a 1A SLO BLO, 5x20mm, available at electronics stores or your dealer (or a 500mA [0.5 amps] SLO BLO 5x20mm if your 1604-VLZ PRO is a 220V-240V unit).

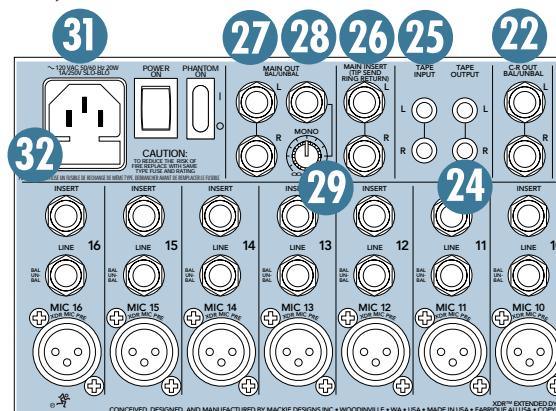

33 POWER SWITCH

If this one isn't self-explanatory, we give up. You can leave this switch on all the time; the 1604-VLZ PRO is conservatively designed, so heat buildup isn't a problem even in 24-hour-a-day operation. There's nothing that will burn out or get used up. You may notice that the 1604-VLZ PRO's "pod" feels quite warm (the pod is the chassis that contains the jacks). This is perfectly normal.

34 POWER LED

You've probably already figured this out, but if the POWER switch is on, this LED (light-emitting diode), located in the output section, will light. If the switch is off, well, you get the idea. If the POWER switch is on and the LED does not glow, one of three things has happened: Somebody tripped over the power cord and yanked it from the outlet, your electricity has been turned off due to nonpayment, or the fuse has blown 32.

35 PHANTOM SWITCH

The PHANTOM switch controls the phantom power supply for condenser microphones as discussed at the start of this section 11. When turned on (or off), the phantom power circuitry takes a few moments for voltage to ramp up (or down). This is also perfectly normal. For an even closer look, refer to **Appendix C**.

36 PHANTOM LED

Located right next to the POWER LED in the output section, this is just to let you know which way you have the PHANTOM switch set. If your dynamic mics work and your condensers don't, chances are this LED is off, so turn it on.

You'll notice that when you turn the phantom power off, the LED stays on for a while. This is a natural phenomenon — the LED is actually a yellow voltmeter telling you that the phantom power takes time to ramp itself down to zero volts. So, if you've turned phantom power off to connect something to the mic inputs, wait until the yellow LED stops glowing and then make your connections safely.

37 BNC LAMP SOCKET

Located in the top right corner of the output section, this 12V socket will drive any standard BNC-type lamp (a Littlite® #12G or #12G-HI (high-intensity), for instance).

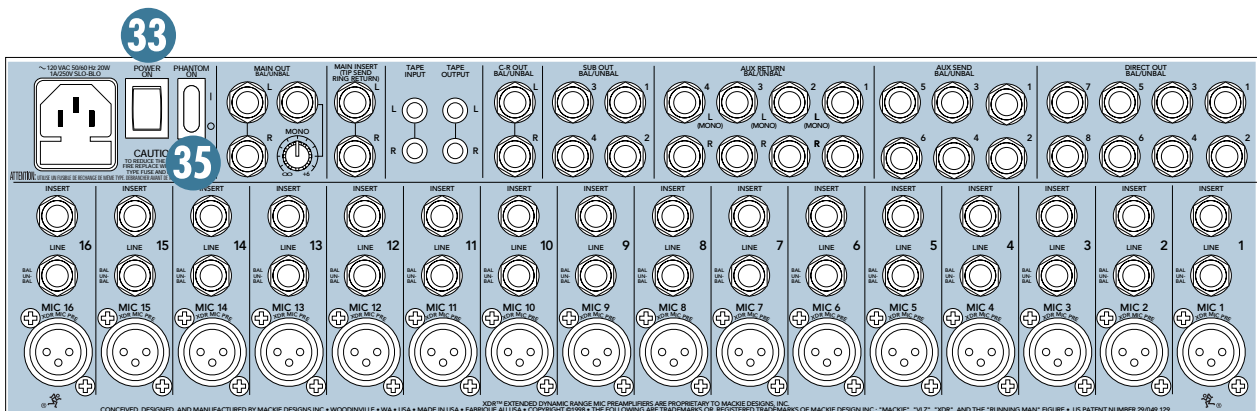
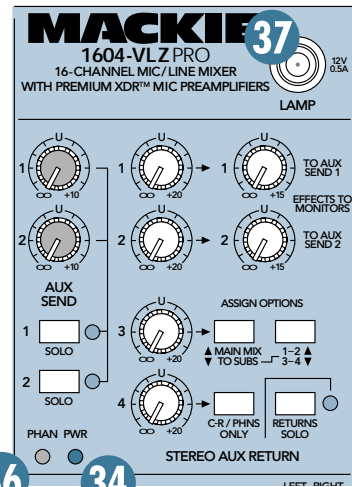

38 CHANNEL STRIP DESCRIPTION

The sixteen channel strips look alike and function identically. The only difference is that the eight on the left have DIRECT OUT jacks 15 and the eight on the right don't. We'll start at the bottom and work our way up.



39 "U" LIKE UNITY GAIN

Mackie mixers have a "U" symbol on almost every level control. This "U" stands for "unity gain," meaning no change in signal level. Once you have performed the **Level-Setting Procedure** 1, you can set every control at "U" and your signals will travel through the mixer at optimal levels. What's more, all the labels on our controls are measured in decibels (dB), so you'll know what you're doing level-wise if you choose to change a control's settings.

You won't have to check it here and check it there, as you would with some other mixers. In fact, some don't even have any reference to actual dB levels at all! Ever seen those "0–10" fader markings? We call these AUMs (Arbitrary Units of Measurement), and they mean nothing in the real world. You were smart — you bought a Mackie.

40 FADER

The fader is almost the last control in a channel's signal path. It's placed after the EQ and MUTE controls (post-EQ /post-MUTE and before the PAN control (pre-PAN). The "U" mark, about three-quarters of the way up, indicates unity gain, meaning no increase or decrease of signal level. All the way up provides an additional 10dB, should you need to boost a section of a song. If you find that the overall level is too quiet or too loud with a fader near unity, you'll want to confirm the TRIM setting by performing the **Level-Setting Procedure** 1.



A Clean Fade

Faders are not rocket science — they operate by dragging a metal pin (the wiper) across a carbon-based strip (the track). It is possible for airborne crud to land on the track. Should that happen, you may hear scratchy noises or signal dropouts as the wiper stumbles over the crud. Do all you can to keep airborne crud out of your profession. Use air conditioned rooms whenever possible, avoid smoking near the mixer, keep food and drink away from the mixer, and for pity's sake, never put the mixer in your kitchen! We also recommend "exercising" the faders — give them a few full-travel excursions once a week or so, and that will help scare the crud away. We do *not* recommend spray cleaners.

41 ASSIGN (1–2, 3–4, L–R)

Alongside each channel fader are four buttons, labeled SOLO, 1–2, 3–4 and L–R. The latter three are collectively referred to as channel assignment switches. 1, 3 and L are the left sides of these stereo pairs, and 2, 4 and R are the right sides. Used in conjunction with the channel's PAN knob 46, these switches determine the destination of a channel's signal: With the PAN knob set at the center detent, the left and right sides receive equal signal levels. To feed only one side or the other, just turn the PAN knob accordingly.

If you're doing a mixdown to a 2-track, simply engage the L–R switch on each channel that you want to hear, and they'll be sent to the MAIN MIX. If you want to create a subgroup of certain channels, engage either the 1–2 or 3–4 switches instead of the L–R, and they'll be sent to the appropriate subgroup faders 56. From there, the subgroups can be sent back to the MAIN MIX 57, allowing you to use the subgroup faders as a master control for those channels.

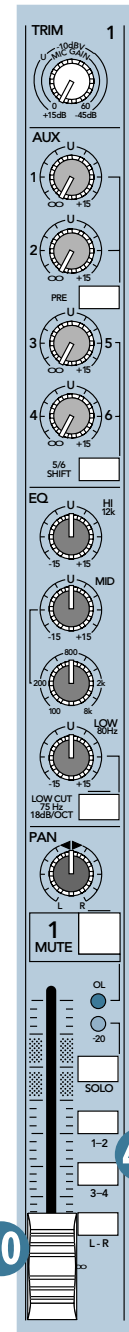

If you're printing new tracks or bouncing existing ones, you'll also use the 1-2 and 3-4 switches, but not the L-R switch. Here, you don't want the subgroups sent back into the MAIN MIX, but sent out, via the SUB OUTS jacks, to your multitrack inputs 16. However, if you're printing tracks via the DIRECT OUT jacks 15, all the channel assignment switches should be disengaged (up).

The 1604-VLZ PRO is what we call a "true 4-bus mixer." Each channel can be assigned or unassigned to any of the subgroups without affecting the other subgroups or settings within the channel, and each subgroup has its own master fader 56 and dedicated output 21. In fact, since there are 4 subgroups *and* the MAIN L-R MIX, it's actually a true 6-bus mixer. We could have named it the CR1606-VLZ. Darn!

42 SOLO

This lovable switch allows you to check signals through your PHONES output or C-R OUTS 42 without having to assign them to the L-R, 1-2 or 3-4 mixes. You can solo as many channels as you like. SOLO does not interrupt any of the other channels, buses or outputs — that's called nondestructive solo. Not only that, via the MODE switch 63, the 1604-VLZ PRO's solo system comes in two flavors: NORMAL (AFL) (sometimes called SIP, or solo-in-place) and LEVEL SET (PFL) (sometimes called PFL, or pre-fader-listen).

During NORMAL (AFL) mode, the soloed channel's signal is sent directly to the C-R OUTS, PHONES output, and meter display just as it would sound to the channel's assignment switches: post-EQ, post-fader and post-PAN. The only difference is that SOLO works regardless of the channel's assignment positions, and that makes it really handy — you can check out a channel before you assign it.

NORMAL (AFL) is the preferred mode during mixdown: If the channel has some midrange boost at 4.236kHz, is panned a smidgen to the left, and its fader is at -5.385dB, that's exactly what you'll hear if you SOLO during NORMAL (AFL) mode. It's just as if you took the time to MUTE all the other channels.

LEVEL SET (PFL) solo is the key player in the all-important **Level-Setting Procedure 1**. It'll send the channel's actual internal levels to the meters so you'll know just what's going on, level-wise. This procedure should be performed every time a new sound source is patched into a channel's MIC or LINE input jacks.

LEVEL SET (PFL) is also the preferred mode for SR (sound reinforcement, or live sound), to preview channels before they are let into the mix. It won't give you stereo placement, but will give you signal even if the fader is pulled down.

Remember, LEVEL SET (PFL) taps the channel signal before the fader. If you have a channel's fader set way below "U" (unity gain), SOLO won't know that and will send a unity gain signal to the C-R OUTS, PHONES output and meter display. That may result in a startling level boost at these outputs, depending on the position of the SOLO level knob 65.

In a nutshell, soloed channels are sent to the SOURCE mix 61, that ultimately feeds your C-R OUTS, PHONES output and meter display. Whenever SOLO is engaged, all SOURCE selections (MAIN MIX, 1-2, 3-4 and TAPE) are defeated, to allow the soloed channel to do just that — SOLO!

43 -20 (SOLO) LED

An LED that does two completely different things! Saves space, but requires some explanation. First, the "-20" part: Often referred to as "signal activity," this LED will flicker in time with the signal present in that channel. It's handy for confirming that a channel is indeed active, and may also lend a clue as to what the signal is. For instance, a kick drum will cause the LED to pulse in time with the drum, and a synth pad will cause it glow a bit more steadily.

Now for the "SOLO" part. When a channel's SOLO switch is engaged, this LED will glow steadily, without flickering. It will also be brighter than it would be as a -20 indicator. In conjunction with the RUDE SOLO LIGHT 66, you can find a rogue SOLO switch very quickly.

44 OL (MUTE) LED

Another LED that does two completely different things! First, the "OL" part: "OL" means overload, or clip. You don't want that to happen. Ever. Clipping can happen to any mixer — it's the point where the signal's voltage exceeds the supply voltages that power the circuitry. The 1604-VLZ PRO's OL LED will come on just before clipping, so if you see it, take immediate action: Perform the **Level-Setting Procedure 1**. If that doesn't help, check for excessive use of EQ boost or fader gain. Like the -20 LED, it will tend to flicker in time with that channel's signal.

Now for the "MUTE" part. Assuming your levels are set correctly, the OL LED will never

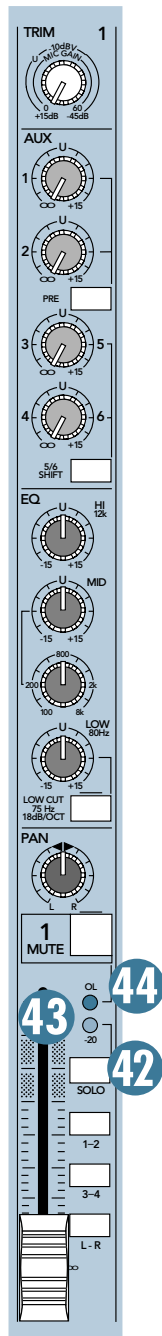

come on as a result of clipping. That's pretty boring. So, to liven things up, this LED will glow steadily when that channel's MUTE switch is engaged.

If you need a quick reference to these LEDs, write this on the back of your hand:

name	color	flickering	glowing
-20 (SOLO)	green	signal is present	channel is soloed
OL (MUTE)	red	channel is clipping	channel is muted

45 MUTE

Engaging a channel's MUTE switch provides the same results as turning the fader all the way down: Any channel assignment to L-R, 1-2 or 3-4 will be interrupted. All the *post* AUX sends 17 will be silenced, as will the DIRECT OUT signals on channels 1 through 8. And of course, that fun-loving OL (MUTE) LED will commence to glow. The PRE AUX sends 51, channel INSERT send 14 and SOLO (in LEVEL SET (PFL) mode) will continue to function during MUTE.

Depending on the audio content in a channel, engaging its MUTE switch may cause a slight popping sound. This is not a problem within the mixer, and it can be avoided: Simply engage the LOW CUT switch 43 on each channel (unless its low frequency content is vitally important, such as a kick drum or bass guitar). LOW CUT eliminates subsonic debris, which causes the pop, and its effect is usually transparent.

46 PAN

PAN adjusts the amount of channel signal sent to the left versus the right outputs. Pan determines the fate of the L-R assignment, subgroups 1-2 and 3-4, and the SOLO (in LEVEL SET (PFL) mode). With the PAN knob hard left, the signal will feed the left MAIN MIX, subgroup 1, subgroup 3 and left NORMAL (AFL) solo mode (assuming their assignment switches are engaged). With the knob hard right, signal feeds the right MAIN MIX, subgroup 2, subgroup 4 and right NORMAL (AFL) solo mode. With the PAN knob set somewhere in-between left and right, the signal will be divided between the left and right busses.

Stereo Sources

Your life will be easier if you follow this standard convention: When patching stereo sound sources to a mixer, always plug the left signal into an "odd" channel (1, 3, 5, etc.) and the right signal into the adjacent "even" channel (2, 4, 6, etc.). Then pan the odd channel hard left and the even channel hard right.



CONSTANT LOUDNESS !!!

The 1604-VLZ PRO's PAN controls employ a design called "Constant Loudness." It has nothing to do with living next to a freeway. As you turn the PAN knob from left to right (thereby causing the sound to move from the left to the center to the right), the sound will appear to remain at the same volume (or loudness).

If you have a channel panned hard left (or right) and reading 0dB, it must dip down about 4dB on the left (or right) when panned center. To do otherwise, like those Brand X mixers, would make the sound appear much louder when panned center.

47 3-BAND MID-SWEEP EQ

The 1604-VLZ PRO has a 3-band, mid-sweep equalization: LOW shelving at 80Hz, MID sweep peaking from 100Hz to 8kHz, and HI shelving at 12kHz. It's probably all the EQ you'll ever need! (Shelving means that the circuitry boosts or cuts all frequencies past the specified frequency. For example, the 1604-VLZ PRO's LOW EQ boosts bass frequencies starting at 80Hz and continuing down to the lowest note you never heard. Peaking means that certain frequencies form a "hill" around the center frequency.)

The LOW EQ provides up to 15dB boost or cut at 80Hz. The circuit is flat (no boost or cut) at the center detent position. This frequency represents the punch in bass drums, bass guitar, fat synth patches, and some really serious male singers.

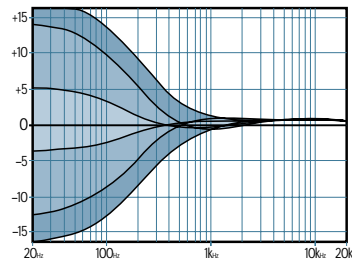

Used in conjunction with the LOW CUT switch 43, you can boost the LOW EQ without injecting a ton of subsonic debris into the mix. We recommend using the LOW CUT feature on all channels, except low frequency signals, like kick drums and bass guitars.

The MID EQ, or "midrange," has a fixed bandwidth of 1.5 octaves. The MID knob sets the amount of boost or cut, up to 15dB, and is effectively bypassed at then center detent. The frequency knob sets the center frequency, sweepable from 100Hz to 8kHz.

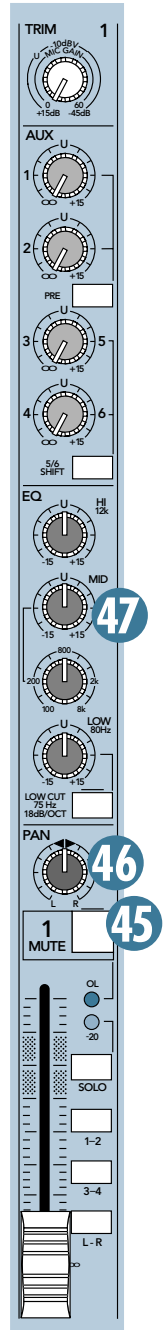

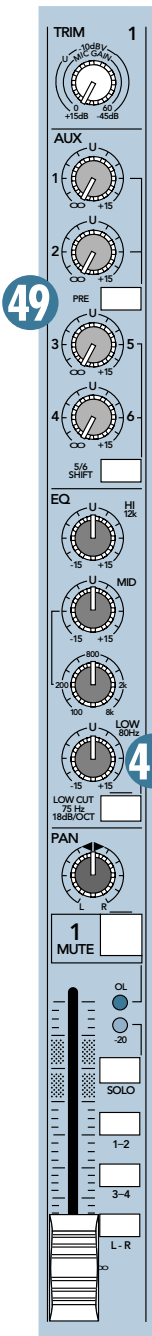

49

48

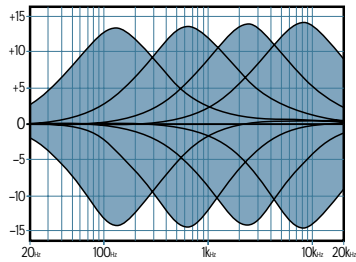
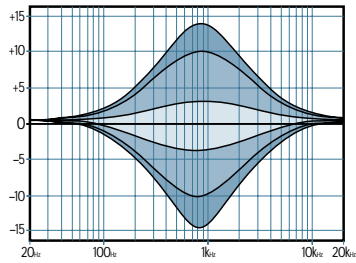

Most of the root and lower harmonics that define a sound are located in the 100Hz–8kHz frequency range, and you can create drastic changes with these two knobs. Many engineers use MID EQ to cut midrange frequencies, not boost them. One popular trick is to set the MID fully up, turn the frequency knob until you find a point where it sounds just terrible, then back the MID down into the cut range, causing those terrible frequencies to disappear. Sounds silly, but it works. Sometimes.

The HI EQ provides you up to 15dB boost or cut at 12kHz, and it is also flat at the detent. Use it to add sizzle to cymbals, an overall sense of transparency, or an edge to keyboards, vocals, guitar and bacon frying. Turn it down a little to reduce sibilance or to mask tape hiss.

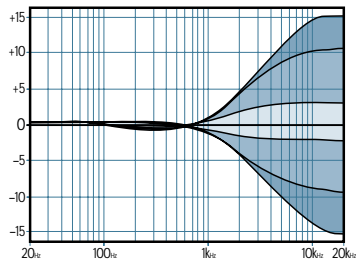

With too much EQ, you can screw things up royally. We've designed a lot of boost and cut into each equalizer circuit because we know everyone will occasionally need that. But if you max the EQ on every channel, you'll get mix mush. Equalize subtly and use the left sides of the knobs (cut), as well as the right (boost). If you find yourself repeatedly using full boost or cut, consider altering the sound source, such as placing a mic differently, trying a different kind of mic, changing the strings, or gargling.

48 LOW CUT

The LOW CUT switch, often referred to as a high pass filter (all depends on how you look at it), cuts bass frequencies below 75Hz at a rate of 18dB per octave. This ain't no thrown-in dime-store filter — an 18dB per octave curve requires an elaborate circuit. Nothing but the best for you.

We recommend that you use LOW CUT on every sound source except kick drum, bass guitar, bassy synth patches, or recordings of earthquakes. These aside, there isn't much down there that you want to hear, and filtering it out makes the low stuff you do want much more crisp and tasty. Not only that, but low cut can help reduce the possibility of feedback in live situations, and it helps to conserve amplifier power.

With LOW CUT, you can safely boost LOW EQ 47. Many times, bass shelving eq can really benefit voices. Trouble is, adding LOW EQ also boosts the subsonic debris: Stage rumble, mic handling clunks, wind noise and breath pops. LOW CUT removes all that debris so you can boost the LOW EQ without frying your woofer. Here's a frequency curve of LOW EQ combined with LOW CUT:

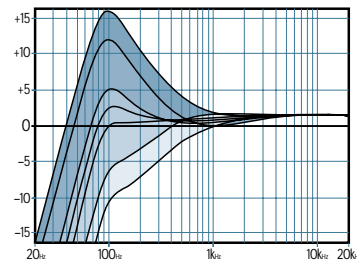

49 AUX 1, 2, 3, & 4

These four knobs tap a portion of each channel's signal, mix them together and send them to the AUX SEND outputs 17. They are off when turned fully down, deliver unity gain at the center detent, and can provide up to 15dB of gain turned fully up. Chances are you'll never need this extra gain, but it's nice to know it's there if you do.

The AUX SEND output are then patched to parallel effects processor inputs 18 or stage monitor amp inputs. AUX SENDS 1 and 2 levels are controlled not only by the channel's AUX knobs, but also by the AUX SEND master knobs 69.

AUX SENDS can also be used to generate separate mixes for recording or "mix-minuses" for broadcast. By using AUX 1 or 2 in the PRE mode 51, these mix levels can be obtained independently of a channel's fader settings.

We recommend going into a stereo reverb in mono and returning in stereo. We have found that on most “stereo” reverbs, the second input just ties up an extra aux send and adds nothing to the sound. There are exceptions, so feel free to try it both ways. Should you choose to use two aux sends, use the “odd” AUX (1, 3 or 5) to feed its left input and the “even” AUX (2, 4 or 6) to feed the right input. Remember, if you’re also dealing with a stereo source signal, you’ll want to follow the sides — use the odd AUX on the channel carrying the left side and the even AUX on the channel carrying the right.

51 PRE

This switch determines the tap point of AUX 1 and 2. Generally, “post” sends are used to feed effects devices, and “pre” sends are used to feed your stage monitors. See the “Pre vs. Post” diagram below. AUX 3 through 6 are always in post mode.

In post mode (switch up), AUX 1 and 2 will follow the EQ, LOW CUT, fader and MUTE settings. If you fade the channel, you fade the send. This is a must for effects sends, since you want the levels of your “wet” signals to follow the level of the “dry.”

In PRE mode (switch down), AUX 1 and 2 follow the TRIM and LOW CUT settings only. EQ, PAN, fader and MUTE settings have no effect on the PRE sends. This is the preferred method for setting up stage monitor feeds — they’ll be controlled independently of the fader and mute moves.

52 5/6 SHIFT

Don’t let the fact that there’s only four AUX knobs per channel fool you — the 1604-VLZ PRO has six AUX SENDS. With the 5/6 SHIFT switch up, the knobs labeled AUX 3 and AUX 4 deliver their signals to AUX SEND 3 and 4 outputs. With the shift switch down, the signals appear at the AUX SEND 5 and 6 outputs.

We recommend that AUX SEND 3 and 4 be patched into your “utility” effects, like a short reverb and slap delay; effects you use all the time. Use AUX SEND 5 and 6 for “exotic” effects, like harmonizers and multi-tap delays; they are not likely to be used as often.

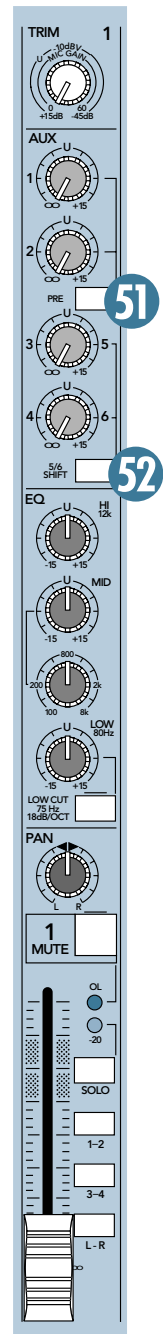
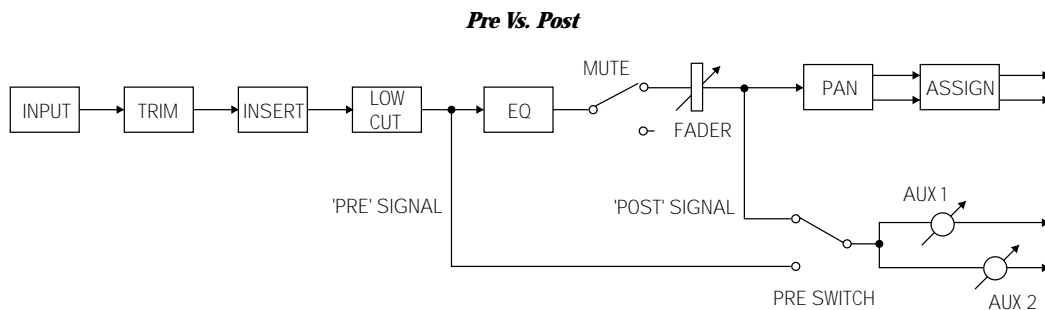

53 OUTPUT SECTION DESCRIPTION

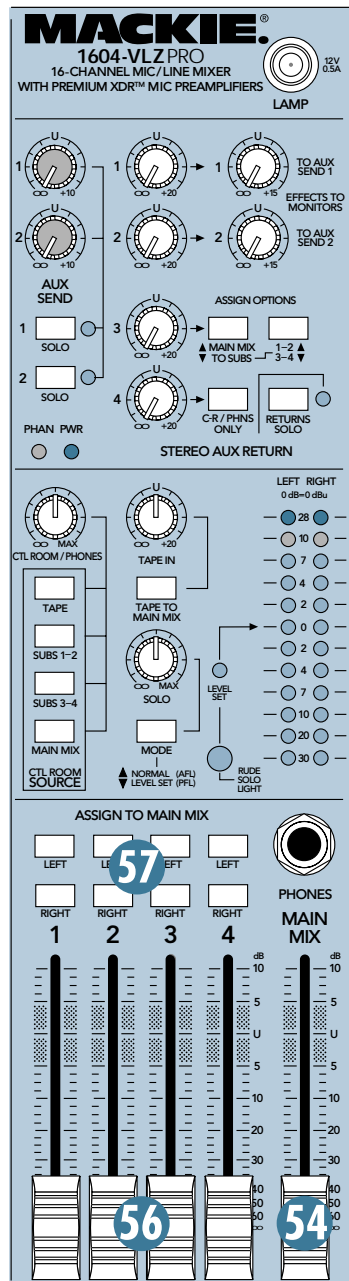

You've just learned about the input channels and how the signals get in and out. The signals come in via MIC and LINE input jacks, are manipulated by the channels, and then sent to the output section. In the output section, things get a bit more complicated, so put on your thinking caps.

54 MAIN MIX FADER

This fader controls the levels of signals sent to the MAIN OUT 1/4" TRS jacks [27](#) and TAPE OUTPUT RCA jacks [24](#). All channels and AUX RETURNS that are assigned to the MAIN MIX, not muted and not turned fully down will appear at the MAIN OUT. Before the main mix gets to this fader, the signals pass through the MAIN INSERT [26](#).

The MAIN MIX signals are off with the fader fully down, the "U" marking is unity gain, and fully up provides 10dB additional gain. This additional gain will typically never be needed, but once again, it's nice to know it's there. The fader itself is a stereo version of the channel and subgroup faders — same supersmooth custom taper, same dead silence when turned fully down. This is the fader to pull down at the end of the song when you want "The Great Fade-Out."

At Mackie, audio quality is much more important than the price of wall warts. All of our mixers now employ VLZ and built-in power supplies that deliver more than enough current, resulting in sonic specifications that rival consoles upwards of \$50,000!

56 SUBGROUP FADERS

As you might expect, these faders control the levels of signals sent to the SUB OUTS. All channels that are assigned to subgroups, not muted and not turned fully down will appear at the SUB OUTS. Unlike the MAIN OUT, the subgroup signals do *not* pass through an insert jack on their way to the subgroup faders. That's no problem — should you want to send these signals through a serial effects processor, simply patch from the SUB OUTS to the effect's input, and from the effect's output to whatever the final destination is, usually a multitrack recorder.

The subgroup signals is off when its fader is fully down, the "U" marking is unity gain, and fully up provides 10dB additional gain. Remember that if you're treating two subgroups as a stereo pair, subgroup 1 and 2 for example, make sure that both subgroup faders "ride" together, to maintain the left/right balance.

57 ASSIGN TO MAIN MIX

One popular use of the subgroups is to use them as master faders for a group of channels on their way to the MAIN MIX. Let's say you've got a drum kit hogging up seven channels and you're going to want to fade them out at a different rate than the other channels. You don't want to try that with seven hands or seven fingers, so just un-assign these channels from L-R, reassign them to subgroup 1-2, engage the ASSIGN TO MAIN MIX, LEFT on subgroup 1 and the ASSIGN TO MAIN MIX, RIGHT on subgroup 2. Now you can ride the entire stereo drum mix with two faders — 1 and 2.

If you engage just one ASSIGN TO MAIN MIX switch per subgroup (LEFT or RIGHT), the signal sent to the MAIN MIX will be the same level as the SUB OUTS. If you want the subgroup to appear in the center of the main mix, engage both the ASSIGN TO MAIN MIX, LEFT and ASSIGN TO MAIN MIX, RIGHT switches. The signal will be sent to both sides, and will be attenuated just enough to preserve constant loudness [46](#), just like the channel PAN knobs when set center.



55 VLZ MIX ARCHITECTURE

When designing a mixing circuit, the lowest noise and best crosstalk specs are achieved by using Very Low Impedance (VLZ). To implement VLZ in a mixer, the power supply must be able to deliver plenty of current to the circuitry. That's why those "wall wart" mixers are often noisy — they can't power a VLZ circuit.

58 TAPE IN (LEVEL)

This knob controls the level of the stereo signal coming from the TAPE INPUT RCA jacks. Its range is off when fully down, unity at the center detent, with 20dB additional gain turned fully up, which may come in handy if you've patched in a "walkperson" type device with wimpy output levels. After the TAPE IN level is determined, the stereo tape signal can be sent to either of two places — the MAIN MIX or the SOURCE matrix 61.

59 TAPE TO MAIN MIX

Engaging this switch is just like engaging the L-R switch on a channel — the signal, stereo in this case, is sent to the MAIN MIX. It does not interrupt other signals, just adds itself to them. This switch can be very handy in a live sound situation when you want to play soothing elevator music to an anxious crowd.



WARNING: Engaging TAPE TO MAIN MIX can create a feedback path between TAPE INPUT and TAPE OUTPUT. Make sure

your tape deck is not in record, record-pause or input monitor mode when you engage this switch, or that the TAPE IN level knob is turned fully down.

61 SOURCE

Typically, the engineer sends the main mix to an audience (if live) or to a mixdown deck (if recording). But what if the engineer needs to hear something other than the main mix? With the New Improved 1604-VLZ PRO, the engineer has several choices of what to listen to. This is one of those tricky parts — have a double espresso first.

Via the SOURCE switches, you can choose to listen to any combination of MAIN MIX, SUBS 1-2, SUBS 3-4 and TAPE. Selections made in the SOURCE matrix deliver stereo signals to the C-R OUTS, PHONES output and meter display. These signals are tapped after their respective level controls — post-MAIN MIX fader, post subgroup faders and post-TAPE IN knob. With no switches engaged, there will be no signal at these outputs and no meter indication, with two exceptions (SOLO 42/65 and AUX RETURN 4 76).

One of those exceptions is the SOLO function 42/65. Regardless of the SOURCE matrix selection, engaging a SOLO switch will replace that selection with the SOLO signal, also sent to the C-R OUTS, PHONES output and meter display. This is what makes the **Level Setting Procedure 1** so easy to do.

Now you know how to select the signals you want to send to the engineer's control room and/or phones. From there, these signals all pass through the same level control, aptly named:

62 CTL ROOM/PHONES

As you might expect, this knob controls the levels of both the stereo C-R OUTS 22 and PHONES output 23. The control range is from off through unity gain at the detent, with 10dB of extra gain (when turned fully clockwise).

When MAIN MIX is your SOURCE selection, those signals will now pass through two level controls on the way to your control room amp and headphones — the MAIN MIX fader and this CTL ROOM/PHONES knob. This way, you can send a nice healthy level to the MAIN OUT jacks (MAIN MIX fader at "U"), and a quieter level to the C-R OUTS or PHONES (CTL ROOM/PHONES knob wherever you like it).

Whatever your selection, you can also use the C-R OUTS for other applications. Its sound quality is just as impeccable as the MAIN OUT outputs. It can be used as additional main mix output and this one will have its own level control. However, should you do this, be aware that if you engage a SOLO switch, that will interrupt the mix, as we've already covered 42.

Once again, engaging a SOLO switch 42 will cause this dramatic turn of events: Any existing SOURCE matrix selections will be replaced by the SOLO signals, appearing at the C-R OUTS, PHONES output and at the meter display. The audible solo levels are controlled by the SOLO level knob. The SOLO levels appearing on the meter display 67 are not controlled by anything — you wouldn't want that. You want to see the actual channel level on the meter display, regardless of how loud you're listening.

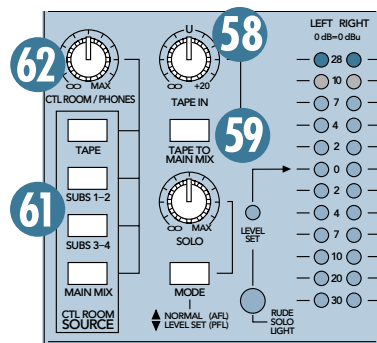

63 MODE (NORMAL (AFL)/LEVEL SET (PFL))

You may have already seen this, but in case you missed it: The 1604-VLZ PRO's solo system comes in two flavors: NORMAL (AFL) (sometimes called SIP, or solo-in-place) and LEVEL SET (PFL) (sometimes called PFL, or pre-fader-listen).

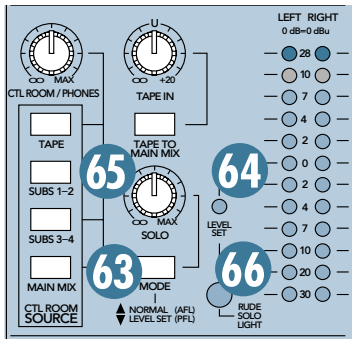

In NORMAL (AFL), the soloed channel's signal is sent directly to the C-R OUTS, PHONES output and meter display just as it would sound to the channel's assignment switches: post-EQ, post-fader and post-PAN. The only difference is that SOLO works regardless of the channel's assignment positions, and that makes it really handy — you can

check out a channel before you assign it.

NORMAL (AFL) is the preferred mode during mixdown: If the channel has some midrange boost at 4.236kHz, is panned a smidgen to the left, and its fader is at -5.385dB , that's exactly what you'll hear if you SOLO during NORMAL (AFL) mode. It's just as if you took the time to MUTE all the other channels.

LEVEL SET (PFL) solo is the key player in the all-important **Level-Setting Procedure 1**. It'll send the channel's actual internal levels to the meters so you'll know just what's going on, level-wise. This procedure should be performed every time a new sound source is patched into a channel's MIC or LINE input jacks.

LEVEL SET (PFL) is also the preferred mode for SR (sound reinforcement, or live sound), to preview channels before they are let into the mix. It won't give you stereo placement, but will give you signal even if the fader is turned down.

Remember, LEVEL SET (PFL) taps the channel signal before the fader. If you have a channel's fader set way below "U" (unity gain), SOLO won't know that and will send a unity gain signal to the C-R OUTS, PHONES output and meter display. That may result in a startling level boost at these outputs, depending on the position of the SOLO level knob 65.

64 LEVEL SET LED

To quote step 6 of the **Level-Setting Procedure 1**, "Push in the MODE switch in the output section (LEVEL SET (PFL) mode) — the LEVEL SET LED will light." When the solo MODE switch is engaged, it's in LEVEL SET (PFL) mode, the mode you must be in to set levels. Now, when you engage any solo switch, this LED will be a "green light" to set levels. If you tried to set levels during NORMAL (AFL) mode, the meter display would be at the mercy of the channel fader, and that would be a big problem.

65 SOLO (LEVEL)

This knob controls the level of the signals coming from the SOLO system. Its range is off when fully down, unity at the center detent, with 10dB additional gain turned fully up. After the SOLO level is determined, the SOLO signals will proceed to take over the C-R OUTS, PHONES output and meter display 61.

Once again, LEVEL SET (PFL) SOLO taps the channel signal before the fader. If you have a channel's fader set way below "U" (unity gain), LEVEL SET (PFL) SOLO won't know that and will send a unity gain signal to the C-R OUTS, PHONES output and meter display. That may result in a startling level boost at these outputs, depending on the position of the SOLO level knob.

66 RUDE SOLO LIGHT

This flashing LED (light emitting diode) serves two purposes — to remind you that you're in SOLO, and to let you know that you're mixing on a Mackie. No other company is so concerned about your level of SOLO awareness. We even force the soloed channel's -20 LED to play along, so you can find that rogue switch fast.

If you work on a mixer that has a SOLO function with no indicator lights, and you happen to forget you're in SOLO, you can easily be tricked into thinking that something is wrong with your mixer. Hence the RUDE SOLO LIGHT. It's especially handy at about 3:00 in the morning, when no sound is coming out of your monitors, even though your multi-track is playing back like mad.

67 METERS

The 1604-VLZ PRO's peak metering system is made up of two columns of twelve LEDs. Deceptively simple, considering the multitude of signals that can be monitored by it. If nothing is selected in the SOURCE matrix (61) and no channels are in SOLO, the meter display will just sit there. To put them to work, you must make a selection in the SOURCE matrix (or engage a SOLO switch).

Why? You want the meter display to reflect what the engineer is listening to, and as we've covered, the engineer is listening either to the C-R OUTS or the PHONES output. The only difference is that while the listening levels are controlled by the CTL ROOM/PHONES knob, the meter display reads the SOURCE mix before that control, giving you the real facts at all times, even if you're not listening at all.

When the solo MODE switch is set to LEVEL SET (PFL) (down) (63), all soloed signals will be sent to the left meter only. That, combined with LEVEL SET LED (64), are along the path of enlightenment known as the **Level-Setting Procedure** (1). During NORMAL (AFL) mode, the meters will behave normally.



Meters vs. Reality

You may already be an expert at the world of “+4” (+4dBu=1.23V) and “-10” (-10dBV=0.32V) operating levels. Basically, what makes a mixer one or the other is the relative 0dB VU (or 0VU) chosen for the meter display. A “+4” mixer, with a +4dBu signal pouring out the back will actually read 0VU on its meter display. A “-10” mixer, with a -10dBV signal trickling out, will read, you guessed it, 0VU on its meter display. So when is 0VU actually 0dBu? Right now!

At the risk of creating another standard, Mackie's compact mixers address the need of both crowds by calling things as they are: 0dBu (0.775V) at the output shows as 0VU on the meter display. What could be easier? By the way, the most wonderful thing about standards is that there are so many to choose from.

Thanks to the 1604-VLZ PRO's wide dynamic range, you can get a good mix with peaks flashing anywhere between -20 and +10dB on the meter display. Most amplifiers clip at about +10dB, and some recorders aren't so forgiving either. For best real-world results, try to keep your peaks between “0” and “+7.”

Please remember: Audio meter displays are just tools to help assure you that your levels are “in the ballpark.” You don't have to stare at them (unless you want to).

68 AUX TALK

First of all, there is no particular alliance between AUX SEND 1 and AUX RETURN 1. They're just numbers. They're like two complete strangers, both named Fred.

Sends are outputs, **returns** are inputs. The AUX knob (49) taps the signal off the channel and sends it to the AUX SEND outputs (17). AUX 1 and 2 are sent to the AUX SENDS 1 and 2 master knobs before the AUX SEND outputs and AUX 3 through 6 are sent directly.

These outputs are fed to the inputs of a reverb or other device. From there, the outputs of the external device are fed back to the mixer's AUX RETURN inputs (19). Then these signals are sent through the AUX RETURN level controls, and finally delivered to the MAIN MIX.

So, the original “dry” signals come from the channels to the MAIN MIX and the affected “wet” signals come from the AUX RETURNS to the MAIN MIX, and once mixed together, the dry and wet signals combine to create a glorious sound. Armed with this knowledge, let's visit the Auxiliary World:

69 AUX SENDS (MASTER)

These knobs provide overall level control of AUX SENDS 1 and 2, just before they're delivered to their AUX SEND outputs (17). This is perfect for controlling the level of stage monitors, since you'll be using AUX 1 and 2 for this, with their PRE switches engaged (51). AUX SENDS 3 through 6 have no such control — they'll just send their mixes directly to their respective AUX SEND outputs at unity gain.

This knob goes from off (turned fully down), to unity gain at the center detent, with 10dB of extra gain (turned fully up). As with some other level controls, you may never need the additional gain, but if you ever do, you'll be glad you bought a Mackie.

This is usually the knob you turn up when the lead singer glares at you, points at his stage monitor, and sticks his thumb in the air. (It would follow suit that if the singer stuck his thumb down, you'd turn the knob down, but that never happens.)

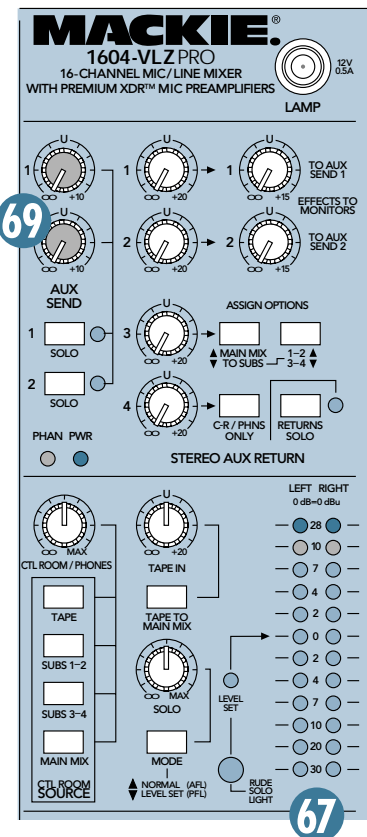

71 AUX SENDS SOLO

Once again, in a live sound situations AUX SEND 1 and 2 are likely to feed your stage monitors. You'll want to check the mix you're sending them, and that's what these two buttons are for. (AUX 3 through AUX 6 have no such switch.) Beside each switch is a green LED that, just like the channel's -20 LED 43, helps you find the rogue SOLO switch.

The only thing different about AUX SENDS SOLO is that it's not really PFL (pre-fader listen), and it's not really SIP (solo-in-place), it's actually AFL (after-fader listen, and yes, we know there's no fader in this case.) During NORMAL (AFL) mode 63, you'll get AUX SEND 1's solo signal, post-AUX SENDS master level, in the left side of the C-R OUTS, PHONES output and meter display, and AUX SEND 2 on the right side. (If you ever use AUX 1 and 2 to create a stereo monitor mix, you'll understand why.) In LEVEL SET (PFL) mode, you'll get the signal dead-center, but still post-AUX SENDS master level.

72 AUX RETURNS (LEVEL)

These four controls set the overall level of effects received from the stereo AUX RETURN input jacks 19. These controls are designed to handle a wide range of signal levels — each knob goes from off, to unity gain at the detent, to 20dB gain fully clockwise, to compensate for

low-level effects. Signals passing through the STEREO AUX RETURN level controls will proceed directly to the MAIN MIX fader 54, with exceptions that we'll discuss in a moment.

Typically, these knobs can just live at the center detent, and the effects device's output control should be set at whatever they call unity gain (check their manual). If that turns out to be too loud or too quiet, adjust the effects device's outputs, not the mixer. That way, the mixer's knobs are easy to relocate at the center detent.

73 EFFECTS TO MONITORS

If you want to add reverb or delay to the stage monitor mixes, these are the knobs for you. Operating independently of their respectively numbered AUX RETURNS level controls, these knobs are exactly the same as the AUX 1 and AUX 2 knobs found in the channel strip 49.

These two knobs feed AUX RETURN signals to their respective AUX SEND outputs 17: TO AUX SEND 1 feeds AUX RETURN 1 to AUX SEND 1 master, and TO AUX SEND 2 feeds AUX RETURN 2 to AUX SEND 2 master. They are off when turned fully down, deliver unity gain at the center detent, and can provide up to 15dB of gain turned fully up. AUX RETURN 3 and AUX RETURN 4 have no such knobs.

74 MAIN MIX TO SUBS (AUX RET 3)

With this switch up, AUX RETURN 3 behaves like all the others — it delivers a stereo signal, regulated by its level knob, to the MAIN MIX 54. When you engage this switch, the signals are removed from the MAIN MIX buses and sent to the 1-2/3-4 switch, which diverts the signal once more. We're not finished. Please read on.

75 1-2/3-4 (AUX RET 3)

As you've just read, if the MAIN MIX TO SUBS switch is disengaged, the 1-2/3-4 switch does absolutely nothing. Let's now assume it's engaged. AUX RETURN 3's stereo signal will not be sent to the MAIN MIX, but to subgroup faders 1 and 2 (1-2/3-4 switch up) or subgroup faders 3 and 4 (switch down).

Let's say you've made a stereo drum submix on subgroup faders 1 and 2, so you can ride those two faders instead of the seven channels that the drums came from. Subgroup fader 1 has its ASSIGN TO MAIN MIX, LEFT button engaged and subgroup fader 2 has its ASSIGN TO MAIN MIX, RIGHT button engaged, blending the drum submix back into the MAIN MIX. The drum channels are also sending signals to your reverb via the AUX sends and the reverb outputs are patched into AUX RETURN 3. So far so good.

Even though you could send AUX RETURN 3 directly to the MAIN MIX (MAIN MIX TO SUBS switch up), you don't want to. Instead, engage the MAIN MIX TO SUBS switch and make sure the 1-2/3-4 switch is up. Now the reverb return will be blended into the drum submix, and as you ride those two faders, the reverb level will follow.

Why do we want that? Because if you had just sent the reverb directly to the MAIN MIX

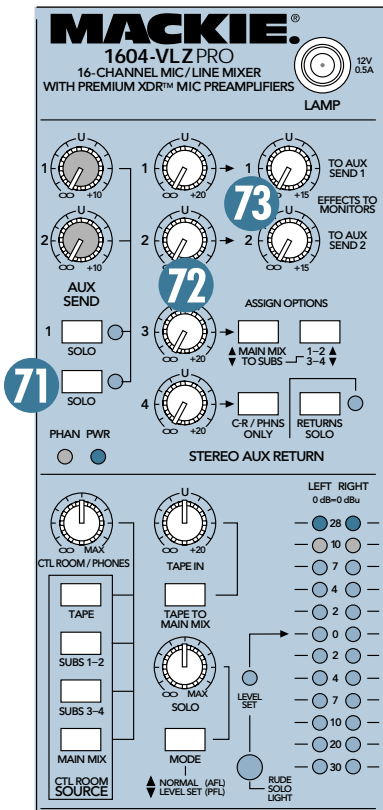

(MAIN MIX TO SUBS switch up) and you did a drum fade-out using subgroup faders 1 and 2, the “dry” signals would fade out, but the “wet” signals would keep on singing. All you would hear is the drum reverb (the “wet”), and none of the original drum signals (the “dry”). That’s because the reverb is being fed by the channel’s AUX sends, and they have no idea that you’ve pulled down the subgroup faders. That’s why we threw in these switches.

76 C-R/PHNS ONLY (AUX RET 4)

Once again, the default for all the STEREO AUX RETURNS is to feed them directly into the MAIN MIX. You’ve just learned about the optional exceptions involving AUX RETURN 3. AUX RETURN 4 also has an optional exception: By engaging the C-R/PHNS switch, you will remove AUX RETURN 4’s stereo signal from the MAIN MIX and send it directly to the CTL ROOM/PHONES SOURCE matrix (61). It matters not if any of the SOURCE matrix switches are assigned, but it will be interrupted, as usual, if a SOLO switch is engaged.

Let’s pretend you’re doing a live mix to a 2-track deck, a house PA, or both, and you want to play along to a click track. You could run the click track directly into the MAIN MIX, but you don’t want the mixdown deck and/or audience to hear it. By gum, this is the switch for you. Similarly, it can be used for voice-over tracks, narration, anything you want heard by the engineer and players but not by the audience and mixdown deck.

77 RETURNS SOLO

This switch operates just like the channel SOLO switches — engaging it sends signals to the C-R OUTS, PHONES output and meter display and interrupts whatever happened to be there before you soloed. It follows the MODE switch (63) setting as well. The only difference is that when you engage the RETURNS SOLO switch, it sends all four STEREO AUX RETURNS signals to the SOLO circuit.

Assume you want to solo the snare drum. Hit that channel’s SOLO switch, and you get the “dry” (no effects) snare only. That helps, but you want to hear it with the reverb you have patched into an AUX RETURN. Leaving that channel’s SOLO switch engaged, also engage the RETURNS SOLO switch, and now you’ll get the dry snare *and* its reverb.

Since it is a global feature, you’ll also get the signals from all the other AUX RETURNS, so there may be some sounds that you didn’t want to hear. If they offend your sensibilities, simply turn down the levels of the STEREO AUX RETURNS you don’t want to hear, or MUTE the channels feeding the unwanted signal to the effects device you *do* want to hear.

Congratulations! You’ve just read about all the features of your 1604-VLZ PRO. You’re probably ready for a cold one. Go ahead. The rest of the manual can wait.

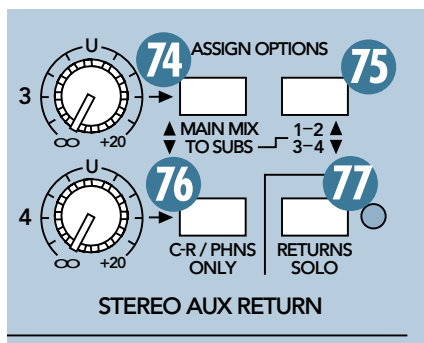

78 MODIFICATIONS



UL Warning

CAUTION! These modification instructions are for use by qualified personnel only. To avoid electric shock, do not perform any servicing other than changing the fuse unless you are qualified to do so. Refer all servicing and modifying to qualified personnel.

Mackie Disclaimer

Any modification of any Mackie Designs product must be performed by a competent electronic technician. Mackie Designs accepts no responsibility for any damages or injuries caused by any modification, regardless of the source of the modification instructions or the qualifications of the technician performing them. In the case of such damages, Mackie Designs may declare warranty privileges void. BE CAREFUL!

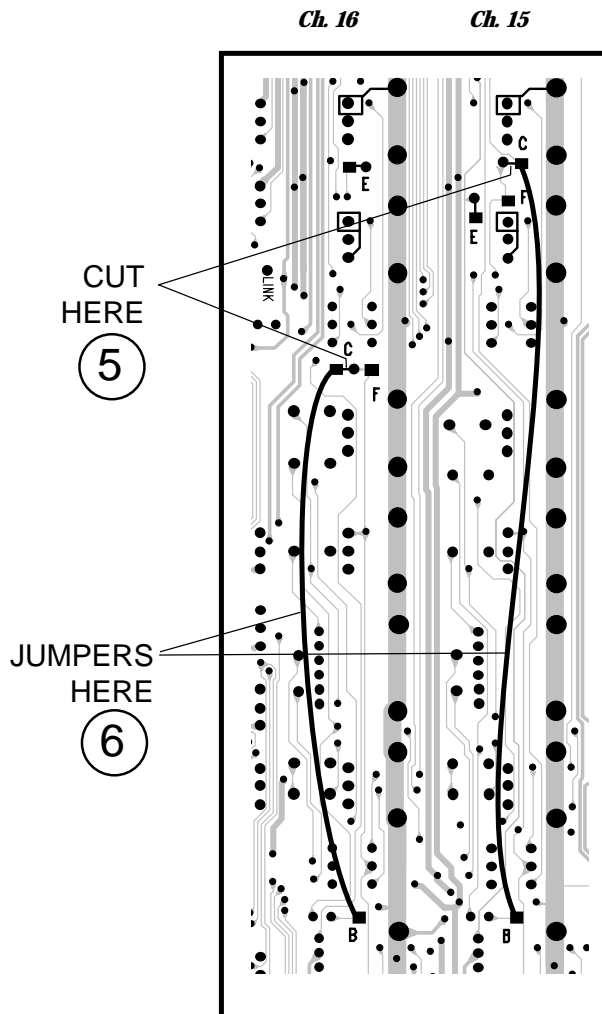

About Jumpers

We recommend solid (non-stranded) wire, 26–28 gauge (wire-wrapping variety). When installing jumpers, do not run their ends through holes in the circuit board. Rather, solder them flat against the desired pad (the flat silver area, possibly with a hole in the middle). Make sure the ends of these flat wires do not extend beyond the pad.

1604-VLZ PRO Post-EQ Mod

This changes AUX SENDS 1 and 2, with the pre switch engaged, to receive their signals *post*-EQ instead of *pre*-EQ. The signal remains post-low cut, pre-mute and pre-fader. With the pre switch disengaged (up), the signals are not affected by the mod. The following must be performed for each channel you wish to modify:

1. Remove all cords, including the power cable, from the 1604-VLZ PRO.
2. Place the mixer upside-down on a dry, non-marring surface.
3. If you have converted your mixer to the rack-mount position or have installed a RotoPod, undo those changes and temporarily configure the mixer in the original desktop mode. You do not have to install the pod, just get it out of the way of the bottom cover.
4. Remove the screws that attach the bottom cover. Keep track of what screws go where. Remove the bottom cover.
5. Cut the conductor at point C, between the square and round pads. Be careful to cut all the way through the conductor, and do not cut any nearby traces. Each channel is slightly different, but this graphic shows Channel 16, which is very different from the others, and Channel 15 (respectively), which is similar to the remaining channels.
6. Add a jumper from the square pad at point B to the square pad at point C.
7. Repeat for each channel you wish to modify.
8. Check your work very carefully, then put the bottom cover back the way you found it. You're done!

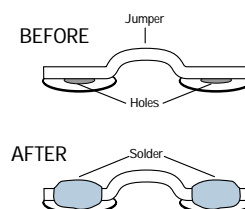



UL Warning

CAUTION! These modification instructions are for use by qualified personnel only. To avoid electric shock, do not perform any servicing other than changing the fuse unless you are qualified to do so. Refer all servicing and modifying to qualified personnel.

Mackie Disclaimer

Any modification of any Mackie Designs product must be performed by a competent electronic technician. Mackie Designs accepts no responsibility for any damages or injuries caused by any modification, regardless of the source of the modification instructions or the qualifications of the technician performing them. In the case of such damages, Mackie Designs may declare warranty privileges void. BE CAREFUL!

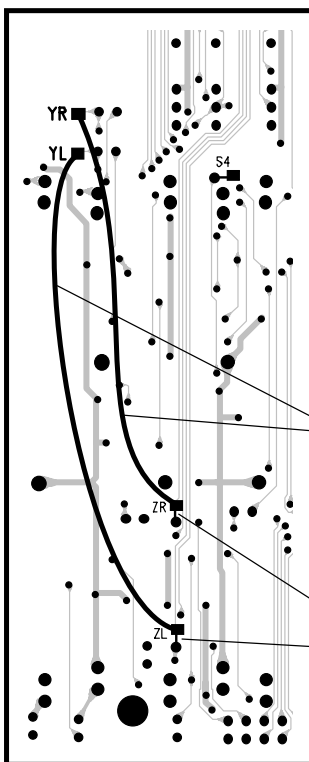
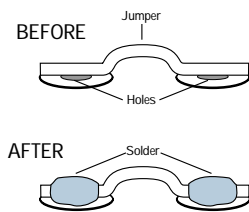

JUMPERS
HERE

8

CUT
HERE

7

About Jumpers

We recommend solid (non-stranded) wire, 26–28 gauge (wire-wrapping variety). When installing jumpers, do not run their ends through holes in the circuit board. Rather, solder them flat against the desired pad (the flat silver area, possibly with a hole in the middle). Make sure the ends of these flat wires do not extend beyond the pad.

1604-VLZ PRO Source Mod

This changes the CTL ROOM/PHONES level control in the SOURCE matrix to receive the main mix stereo signal *pre*-MAIN MIX fader instead of *post*-MAIN MIX fader.

You can accomplish the same result that this modification provides by using two standard ¼" tip-sleeve "jumper cables" plugged into the MAIN INSERT (L and R) to the *first click* and the other end plugged into STEREO AUX RETURN 4, assigned to C-R/PHNS ONLY. STEREO AUX RETURN 4 level will control the volume as well as CTL ROOM/PHONES level control.

You can also use the TAPE INPUT (L and R) RCA jacks (you will need ¼" to RCA cables or adapters) and assign the TAPE source button in the SOURCE matrix.

1. Remove all cords, including the power cable, from the 1604-VLZ PRO.
2. Undo the PHONES nut.
3. Place the mixer upside-down on a dry, non-marring surface.
4. If you have converted your mixer to the rack-mount position or have installed a RotoPod, undo those changes and temporarily configure the mixer in the original desktop mode. You do not have to install the pod, just get it out of the way of the bottom cover.
5. Remove the screws that attach the bottom cover. Keep track of what screws go where. Remove the bottom cover.
6. Move the PHONES board to one side so you can get to points YL and YR marked on the board.
7. Cut the conductor at points ZL and ZR, between the square and round pads. Be careful to cut all the way through the conductor, and do not cut any nearby traces.
8. Add a jumper from the square pad at point YL to the square pad at point ZL and another from the square pad at point YR to the square pad at point ZR.
9. Check your work very carefully, then put the Phono board and nut, and bottom cover back the way you found them. You're done!

79 1604-VLZ PRO BLOCK DIAGRAM

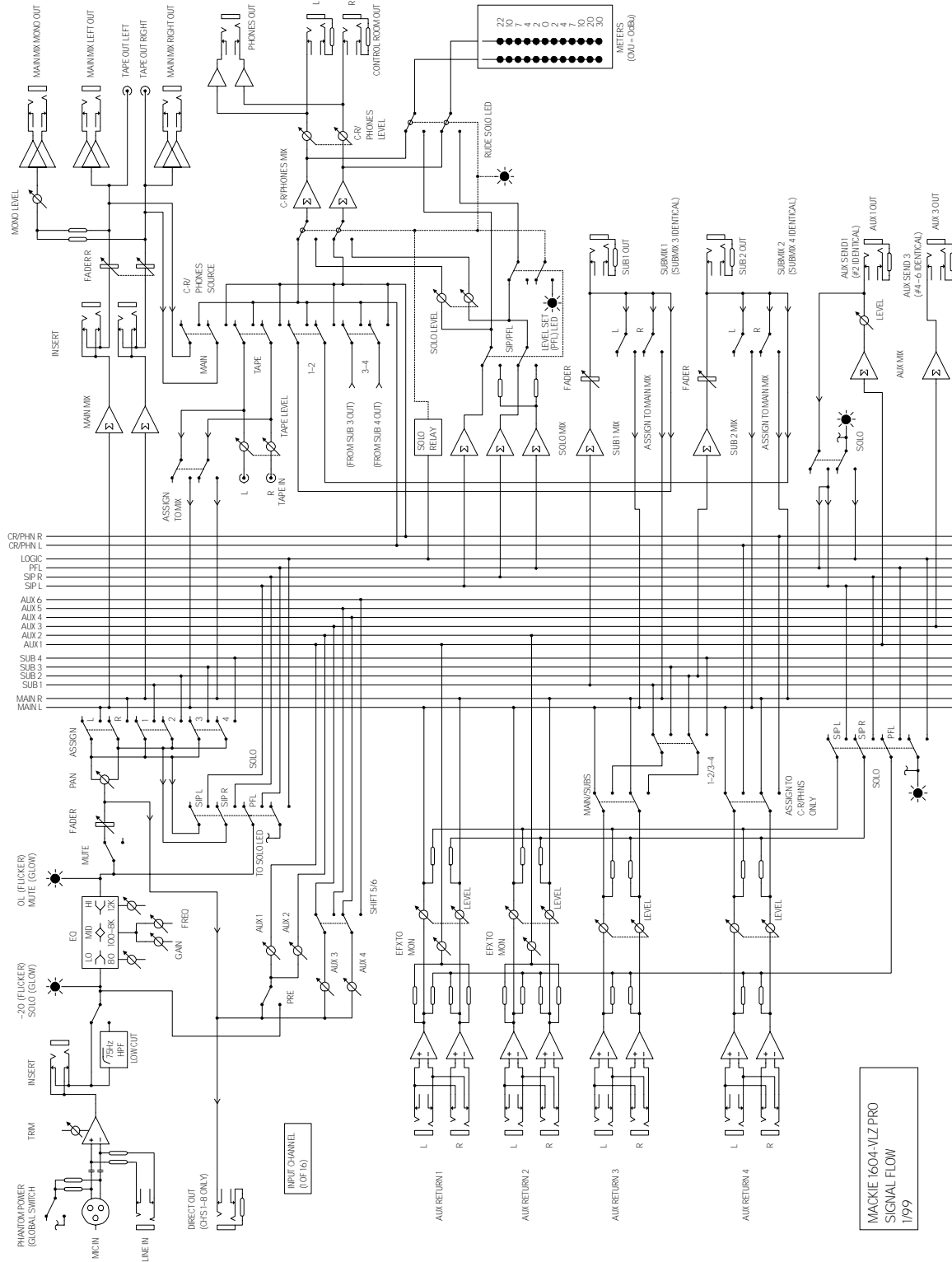

MACKIE 1604-VLZ PRO
SIGNAL FLOW
1/99

80 GAIN STRUCTURE DIAGRAM

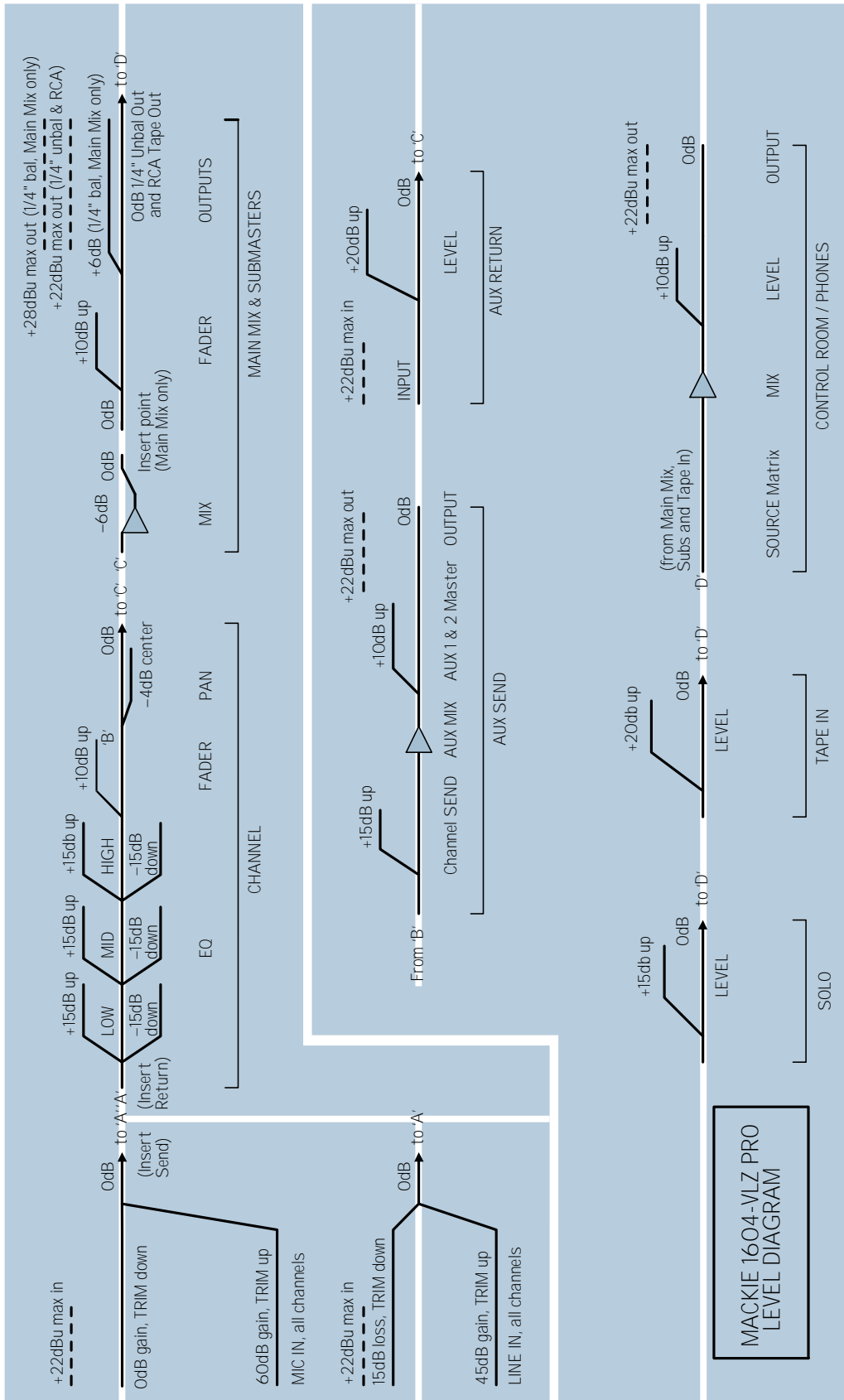

MACKIE 1604-VLZ PRO LEVEL DIAGRAM

81 SPECIFICATIONS

Main Mix Noise

20Hz–20kHz bandwidth, 1/4" Main Out, channel Trims @ unity gain, channel EQs flat, all channels assigned to Main Mix, odd channels panned left, even channels panned right

Main Mix fader unity, channel faders down: -86.5dBu
(90dB Signal to Noise Ratio, ref +4dBu)
Main Mix fader @ unity, channel faders @ unity: -84.0dBu

Total Harmonic Distortion (THD)

1kHz @ +14dBu: 20Hz–20kHz
Mic in to Main out: below 0.0007%

Attenuation (Crosstalk)

1kHz relative to 0dBu, 20Hz–20kHz bandwidth,
Line in, 1/4" Main Out, Trim @ unity

Channel Mute switch engaged: -84dBu
Channel Gain knob down: -84dBu

Frequency Response

Mic input to any output

20Hz to 60kHz: +0dB/-1dB
20Hz to 100kHz: +0dB/-3dB

Equivalent Input Noise (EIN)

Mic in to Insert Send out, max gain

150 ohm termination: -129.5dBm unweighted

Common Mode Rejection (CMR)

Mic in to Insert Send out, max gain

1kHz: better than 90dB

Maximum Levels

Mic in: +22dBu
All other inputs: +22dBu
Main Mix 1/4" TRS outputs: +28dBu
All other outputs: +22dBu

Impedances

Mic in: 1.3 kilohms
Channel Insert return: 2.5 kilohms
All other inputs: 10 kilohms or greater
Tape out: 1.1 kilohms
All other outputs: 120 ohms

EQ

High Shelving: ±15dB @ 12kHz
Mid Peaking: ±15dB, sweep 100Hz–8kHz
Low Shelving: ±15dB @ 80Hz
Low Cut Filter: 18dB/octave, -3dB @ 75Hz

Power Consumption

120VAC, 50/60Hz, 50 watts

Fuse Ratings

120V: 1A Slo Blo, 5 x 20mm
220–240V: 0.5A Slo Blo, 5 x 20mm

Weight

20 lbs. (9.1kg)

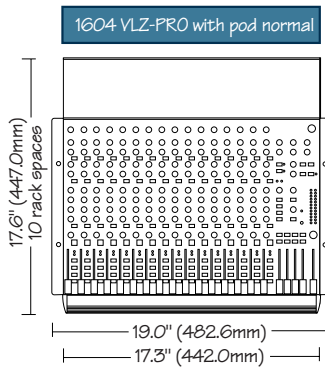

5.0" (127mm)

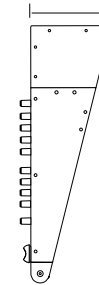

5.6" (142.2mm)

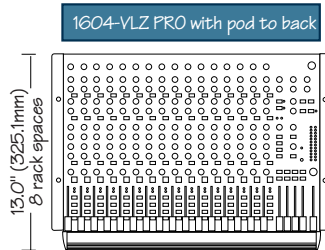
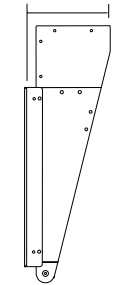

8.7" (221.0mm)

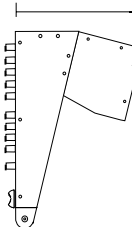

9.3" (236.2mm)

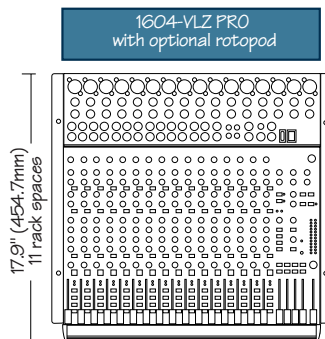
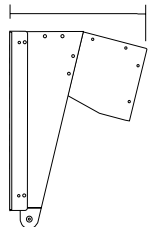

6.0" (152.4mm)

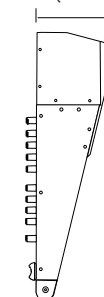

6.6" (167.6mm)

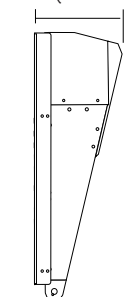

82 SERVICE INFO

Details concerning Warranty Service are spelled out on the Warranty Card included with your mixer (if it's missing, let us know and we'll rush one to you).

If you think your 1604-VLZ PRO has a problem, please do everything you can to confirm it before calling for service. Doing so might save you from being deprived of your mixer.

Of all Mackie products returned for service (which is hardly any at all), roughly 50% are coded "CND" — Could Not Duplicate, which usually means the problem lies somewhere other than the mixer. These may sound obvious to you, but here's some things you can check:

TROUBLESHOOTING

Bad Channel

- Are the channels assigned to the correct mix (1-2, 3-4, L-R)?
- Is the fader up?
- Try unplugging any insert devices from the INSERT jacks.
- Try the same source signal in another channel, set up exactly like the suspect channel.

Bad Output

- Is the associated level control (if any) turned up?
- If you're listening to the C-R OUTS or PHONES outputs, has a SOURCE selection been made?
- If it's one of the MAIN OUTS, try unplugging its companion. For example, if it's the 1/4" LEFT MAIN OUT, unplug the RCA output. If the problem goes away, it's not the mixer.
- If it's a stereo pair, try switching them around. For example, if a left output is presumed dead, switch the left and right cords, at the mixer end. If the problem stays on the left, it's not the mixer.
- Unplug everything from the MAIN INSERTS.

Noise

- Turn the channel faders and AUX RETURN knobs down, one by one. If the sound disappears, it's either that channel or whatever is plugged into it, so unplug whatever that is. If the noise disappears, it's from your whatever.

Power

Our favorite question: Is the POWER switch on?
Check the fuse .

REPAIR

Service for the U.S. version of the 1604-VLZ PRO is only available from Mackie Designs, located in sunny Woodinville, Washington. (Service for mixers living outside the United States can be obtained through local dealers or distributors.) If your mixer needs service, follow these instructions:

1. Review the preceding troubleshooting suggestions. Please.
2. Call Tech Support at 1-800-258-6883, 8am to 5pm PST, to explain the problem and request an R.A. number. Have your mixer's serial number ready. **You must have a Return Authorization number; or we may refuse the delivery.**
3. Set aside the power cord, owner's manual, or anything else that you'll ever want to see again. We are responsible for the return of the mixer only.
4. Pack the mixer in its original package, including endcaps and box. This is **VERY IMPORTANT**. When you call for the RA number, please let Tech Support know if you need a new box. *Mackie is not responsible for any damage that occurs due to non-factory packaging.*
5. Include a legible note stating your name, shipping address (no P.O. boxes), daytime phone number, R.A. number and a detailed description of the problem, including how we can duplicate it.
6. Write the R.A. number in **BIG PRINT** on top of the box.
7. Ship the mixer to us. We recommend United Parcel Service (UPS). We suggest insurance for all forms of cartage. Ship to this address:
Mackie Designs Inc.
SERVICE DEPARTMENT
16220 Wood-Red Rd. NE
Woodinville, WA 98072
8. We'll try to fix the mixer within three business days. Ask Tech Support for the latest turn-around times when you call for your RA number. We normally send everything back prepaid using UPS BLUE (Second Day Air). However, if you rush your mixer to us by Next Day Air, we'll ship it back to you UPS RED (Next Day Air). This paragraph does not necessarily apply to non-warranty service.

APPENDIX A: GLOSSARY

This Glossary contains brief definitions of many of the audio and electronic terms used in discussions of sound mixing and recording. Many of the terms have other meanings or nuances or very rigorous technical definitions which we have sidestepped here because we figure you already have a lot on your mind. If you'd like to get more information, you can call Mix Bookshelf at 1-800-233-9604. We recommend the following titles: *The Audio Dictionary*, by Glenn White; *Tech Terms*, by Peterson & Oppenheimer; *Handbook for Sound Engineers*, by Glen Ballou; *Mackie Mixer Book* by Rudy Trubitt and *Sound Reinforcement Handbook*, by Gary Davis.

AFL

An acronym for After Fade Listen, which is another way of saying post-fader solo function.

assign

In sound mixers, *assign* means to switch or route a signal to a particular signal path or combination of signal paths.

attenuate

To reduce or make quieter.

aux

See next entry.

auxiliary

In sound mixers, supplemental equipment or features that provide additional capabilities to the basic system. Examples of auxiliary equipment include: serial processors (equalizers, compressors, limiters, gates) and parallel devices (reverberation and delay). Most mixers have aux send buses and aux return inputs to accommodate auxiliary equipment.

balanced

In a classic balanced audio circuit, the two legs of the circuit (+ and -) are isolated from the circuit ground by exactly the same impedance. Additionally, each leg may carry the signal at exactly the same level but with opposite polarity with respect to ground. In some balanced circuits, only one leg actually carries the signal but both legs exhibit the same impedance characteristics with respect to ground. Balanced input circuits can offer excellent rejection of common-mode noise induced into the line and also make proper (no ground loops) system grounding easier. Usually terminated with 1/4" TRS or XLR connectors.

bandwidth

The band of frequencies that pass through a device with a loss of less than 3dB, expressed in Hertz or in musical octaves. Also see *Q*.

bus

An electrical connection common to three or more circuits. In mixer design, a bus usually carries signals from a number of inputs to a mixing amplifier, just like a city bus carries people from a number of neighborhoods to their jobs.

Cannon

A manufacturer of electrical connectors who first popularized the three-pin connector now used universally for balanced microphone connections. In sound work, a Cannon connector is taken to mean a Cannon XLR-3 mic connector or any compatible connector.

cardioid

Means heart-shaped. In sound work, cardioid refers to the shape of the sensitivity pattern of some directional microphones.

channel

A functional path in an audio circuit: an input channel, an output channel, a recording channel, the left channel and so on.

channel strip

The physical representation of an audio channel on the front panel of a mixer; usually a long, vertical strip of controls.

chorusing

An effect available in some digital delay effects units and reverbs. Chorusing involves a number of moving delays and pitch shifting, usually panned across a stereo field. Depending on how used, it can be lovely or grotesque.

clipping

A cause of severe audio distortion that is the result of excessive gain requiring the peaks of the audio signal to rise above the capabilities of the amplifier circuit. Seen on an oscilloscope, the audio peaks appear clipped off. To avoid distortion, reduce the system gain in or before the gain stage in which the clipping occurs. See also *headroom*.

condenser

Another term for the electronic component generally known as a capacitor. In audio, condenser usually refers to a type of microphone that uses a capacitor as the sound pickup element. Condenser microphones require electrical power to run internal amplifiers and maintain an electrical charge on the capacitor. They are typically powered by internal batteries or "phantom power" supplied by an external source, such as a mixing console.

console

A term for a sound mixer, usually a large desk-like mixer.

cueing

In broadcast, stage and post-production work, to “cue up” a sound source (a record, a sound effect on a CD, a song on a tape) means to get it ready for playback by making sure you are in the right position on the “cue,” making sure the level and EQ are all set properly. This requires a special monitoring circuit that only the mixing engineer hears. It does not go out on the air or to the main mixing buses. This “cueing” circuit is the same as pre-fader (PFL) solo on a Mackie mixer, and often the terms are interchangeable.

dB

See *decibel*.

dBm

A unit of measurement of audio signal level in an electrical circuit, expressed in decibels referenced to 1 milliwatt. The “m” in dBm stands for “milliwatt.” In a circuit with an impedance of 600 ohms, this reference (0dBm) corresponds to a signal voltage of 0.775 VRMS (because 0.775 V across 600 ohms equals 1mw).

dBu

A unit of measurement of audio signal level in an electrical circuit, expressed in decibels referenced to 0.775 VRMS into any impedance. Commonly used to describe signal levels within a modern audio system.

dBv

A unit of measurement equal to the dBu but no longer in use. It was too easy to confuse a dBv with a dBV, to which it is not equivalent.

dBV

A unit of measurement of audio signal level in an electrical circuit, expressed in decibels referenced to 1 VRMS across any impedance. Commonly used to describe signal levels in consumer equipment. To convert dBV to dBu, add 2.2dB.

decibel (dB)

The dB is a ratio of quantities measured in similar terms using a logarithmic scale. Many audio system parameters measure over such a large range of values that the dB is used to simplify the numbers. A ratio of 1000V:1V=60dB. When one of the terms in the ratio is an agreed upon standard value such as 0.775V, 1V or 1mw, the ratio becomes an absolute value, i.e., +4dBu, -10dBV or 0dBm.

delay

In sound work, delay usually refers to an electronic circuit or effects unit whose purpose it is to delay the audio signal for some short period of time. Delay can refer to one short repeat, a series of repeats or the complex interactions of delay used in chorusing or reverb. When delayed signals are mixed back with the original sound, a great number of audio effects can be generated, including phasing and flanging, doubling, Haas-effect positioning, slap or slapback, echo, regenerative echo, chorusing and hall-like reverberation. Signal time delay is central to many audio effects units.

detent

A point of slight physical resistance (a click-stop) in the travel of a knob or slide control, used in Mackie mixers to indicate unity gain.

dipping

The opposite of peaking, of course. A dip is an EQ curve that looks like a valley, or a dip. Dipping with an equalizer reduces a band of frequencies. (See *guacamole*.)

doubling

A delay effect, where the original signal is mixed with a medium (20 to 50 msec) delay. When used carefully, this effect can simulate double-tracking (recording a voice or instrument twice).

dry

Usually means without reverberation, or without some other applied effect like delay or chorusing. Dry is not wet, i.e. totally unaffected.

dynamic

In sound work, dynamic refers to the class of microphones that generate electrical signals by the movement of a coil in a magnetic field. Dynamic microphones are rugged, relatively inexpensive, capable of very good performance and do not require external power.

dynamic range

The range between the maximum and minimum sound levels that a sound system can handle. It is usually expressed in decibels as the difference between the level at peak clipping and the level of the noise floor.

echo

The reflection of sound from a surface such as a wall or a floor. Reverberation and echo are terms that can be used interchangeably, but in audio parlance a distinction is usually made: echo is considered to be a distinct, recognizable repetition (or series of repetitions) of a word, note, phrase or sound, whereas reverberation is a diffuse, continuously smooth decay of sound. Echo and reverberation can be added in sound mixing by sending the original sound to an electronic (or electronic/acoustic) system that mimics natural echoes, and then some. The added echo is returned to the blend through additional mixer inputs. Highly echoic rooms are called live; rooms with very little echo are called dead. A sound source without added echo is dry; one with reverb or echo added is wet.

effects devices

External signal processors used to add reverb, delay, spatial or psychoacoustic effects to an audio signal. An effects processor may be used as an insert processor (serial) on a particular input or subgroup, or it may be used via the aux send/return system (parallel). See also **echo, reverb**.

EIN

Equivalent Input Noise. Specification that helps measure the “quietness” of a gain stage by deriving the equivalent input noise voltage necessary to obtain a given preamp's output noise. Typically ranges from -125 to -129.5 dBm.

EQ

See **equalization**.

EQ curve

A graph of the response of an equalizer, with frequency on the x (horizontal) axis and amplitude (level) on the y (vertical) axis. Equalizer types and effects are often named after the shape of the graphed response curve, such as peak, dip, shelf, notch, knee and so on.

equalization

Equalization (EQ) refers to purposefully changing the frequency response of a circuit, sometimes to correct for previous unequal response (hence the term, equalization), and more often to add or subtract level at certain frequencies for sound enhancement, to remove extraneous sounds, or to create completely new and different sounds.

Bass and treble controls on your stereo are EQ; so are the units called parametrics and graphics and notch filters.

A lot of how we refer to equalization has to do with what a graph of the frequency response would look like. A flat response (no EQ) is a straight line; a peak looks like a hill, a dip is a valley, a notch is a really skinny valley, and a shelf looks like a plateau (or a shelf). The slope is the grade of the hill on the graph.

Graphic equalizers have enough frequency slider controls to form a graph of the EQ right on the front panel. Parametric EQs let you vary several EQ parameters at once. A filter is simply a form of equalizer that allows certain frequencies through unmolested while reducing or eliminating other frequencies.

Aside from the level controls, EQs are probably the second most powerful controls on any mixer (no, the power switch doesn't count!).

fader

Another name for an audio level control. Today, the term refers to a straight-line slide control rather than a rotary control.

family of curves

A composite graph showing on one chart several examples of possible EQ curves for a given equalizer or equalizer section.

filter

A simple equalizer designed to remove certain ranges of frequencies. A low-cut filter (also called a high-pass filter) reduces or eliminates frequencies below its cutoff frequency. There are also high-cut (low-pass) filters, bandpass filters, which cut both high and low frequencies but leave a band of frequencies in the middle untouched, and notch filters, which remove a narrow band but leave the high and low frequencies alone.

flanging

A term for phasing. Before digital delay effects units, phasing could be accomplished by playing two tape machines in synchronization, then delaying one slightly by rubbing a finger on the reel flange. Get it?

FOH

An acronym for Front Of House. See **house** and **main house speakers**.

frequency

The number of times an event repeats itself in a given period. Sound waves and the electrical signals that represent sound waves in an audio circuit have repetitive patterns that range from a frequency of about 20 repetitions per second to about 20,000 repetitions per second. Sound is the vibration or combination of vibrations in this range of 20 to 20,000 repetitions per

second, which gives us the sensation of pitch, harmonics, tone and overtones. Frequency is measured in units called Hertz (Hz). One Hertz is one repetition or cycle per second.

gain

The measure of how much a circuit amplifies a signal. Gain may be stated as a ratio of input to output values, such as a voltage gain of 4, or a power gain of 1.5, or it can be expressed in decibels, such as a line amplifier with a gain of 10dB.

gain stage

An amplification point in a signal path, either within a system or a single device. Overall system gain is distributed between the various gain stages.

graphic EQ

A graphic equalizer uses slide pots for its boost/cut controls, with its frequencies evenly spaced through the audio spectrum. In a perfect world, a line drawn through the centers of the control shafts would form a graph of the frequency response curve. Get it? Or, the positions of the slide pots give a graphic representation of boost or cut levels across the frequency spectrum.

ground

Also called earth. Ground is defined as the point of zero voltage in a circuit or system, the reference point from which all other voltages are measured. In electrical systems, ground connections are used for safety purposes, to keep equipment chassis and controls at zero voltage and to provide a safe path for errant currents. This is called a safety ground.

Maintaining a good safety ground is always essential to prevent electrical shock. Follow manufacturer's suggestions and good electrical practices to ensure a safely grounded system. Never remove or disable the grounding pin on the power cord.

In computer and audio equipment, tiny currents and voltages can cause noise in the circuits and hamper operation. In addition to providing safety, ground provisions in these situations serve to minimize the pickup, detection and distribution of these tiny noise signals. This type of ground is often called technical ground.

Quality audio equipment is designed to maintain a good technical ground and also operate safely with a good safety ground. If you have noise in your system due to technical grounding problems, check your manual for wiring tips or call technical support. Never disable the safety ground to reduce noise problems.

ground loop

A ground loop occurs when the technical ground within an audio system is connected to the safety ground at more than one place. Two or more connections will allow tiny currents to flow in the loops created, possibly inducing noise (hum) in the audio system. If you have noise in your system due to ground loops, check your manual for wiring tips or call technical support. Never disable the safety ground to reduce noise problems.

Haas effect

A psychoacoustic effect in which the time of arrival of a sound to the left and right ears affects our perception of direction. If a signal is presented to both ears at the same time at the same volume, it appears to be directly in front of us. But if the signal to one ear, still at the same volume, is delayed slightly (0 to 5 msec), the sound appears to be coming from the earlier (non-delayed) side.

headroom

The difference between nominal operating level and peak clipping in an audio system. For example, a mixer operating with a nominal line level of +4dBu and a maximum output level of +22dBu has 18dB of headroom. Plenty of room for surprise peaks.

Hertz

The unit of measure for frequency of oscillation, equal to 1 cycle per second. Abbreviated Hz. KHz is pronounced "kay-Hertz" and is an abbreviation for kilohertz, or 1000 Hertz.

house

In Sound Reinforcement parlance, "house" refers to the systems (and even persons) responsible for the primary sound reinforcement in a given hall, building, arena or "house." Hence we have the house mixer or house engineer, the house mix, the house mix amps, the main house speakers and so on.

Hz

See *Hertz*.

impedance

The A.C. resistance/capacitance/inductance in an electrical circuit, measured in ohms. In audio circuits (and other AC circuits) the impedance in ohms can often be much different from the circuit resistance as measured by a DC ohmmeter.

Maintaining proper circuit impedance relationships is important to avoid distortion and minimize added noise. Mackie input and output impedances are set to work well with the vast majority of audio equipment.

input module

A holdover from the days when the only way that real consoles were built was in modular fashion, one channel per module. See *channel strip*.

knee

A knee is a sharp bend in an EQ response curve not unlike the sharp bend in your leg. Also used in describing dynamics processors.

level

Another word for signal voltage, power, strength or volume. Audio signals are sometimes classified according to their level. Commonly used levels are: microphone level (−40dBu or lower), instrument level (−20 to −10dBu), and line level (−10 to +30dBu).

line level

A signal whose level falls between −10dBu and +30dBu.

main house speakers

The main loudspeakers for a sound reinforcement system. These are usually the largest and loudest loudspeakers, and are usually positioned so that their sound seems to come from the area of the main stage.

mains

See *main house speakers*.

master

A control affecting the final output of a mixer. A mixer may have several master controls, which may be slide faders or rotary controls.

mic amp

See *mic preamp*.

mic level

The typical level of a signal from a microphone. A mic level signal (usually but not always coming from a microphone) is generally below −30dBu. With a very quiet source (a pin dropping?) the signal can be −70dBu or lower. It is also possible for some microphones to deliver more signal than this, in which case it may be referred to as a “hot” mic level. Alternatively, you can just say, “Boy, is that loud!”

mic pre

See *mic preamp*.

mic preamp

Short for microphone preamplifier. An amplifier that functions to bring the very low signal level of a microphone (approximately −50dBu) up to line level (approximately 0dBu). Mic preamps often have their own volume control, called a trim control, to properly set the gain for a particular source. Setting the mic preamp gain correctly with the trim control is an essential step in establishing good noise and headroom for your mix.

mixer

An electronic device used to combine various audio signals into a common output. Different from a blender, which combines various fruits into a common libation.

monaural

Literally, pertaining to or having the use of only one ear. In sound work, monaural has to do with a signal which, for purposes of communicating audio information, has been confined to a single channel. One microphone is a mono pickup; many microphones mixed to one channel is a mono mix; a mono signal played through two speakers is still mono, since it only carries one channel of information. Several monaural sources, however, can be panned into a stereo (or at least two-channel, if you are going to be picky) mix. Monaural SR is common for environments where stereo SR would provide an uneven reproduction to the listener.

monitor

In sound reinforcement, monitor speakers (or monitor headphones or in-the-ear monitors) are those speakers used by the performers to hear themselves. Monitor speakers are also called foldback speakers. In recording, the monitor speakers are those used by the production staff to listen to the recording as it progresses. In zoology, the monitor lizard is the lizard that observes the production staff as the recording progresses. Keep the lizard out of the mixer.

mono

Short for monaural.

mult

Probably short for multiple. In audio work, a mult is a parallel connection in a patch bay or a connection made with patch cords to feed an output to more than one input. A “Y” cable is a type of mult connection. Also a verb, as in “Why did you mult the flanger into every input in the board?”

noise

Whatever you don’t want to hear. Could be hum, buzz or hiss; could be crosstalk or digital hash or your neighbor’s stereo; could be white noise or pink noise or brown noise; or it could be your mother-in-law reliving the day she had her gallstone removed.

noise floor

The residual level of noise in any system. In a well designed mixer, the noise floor will be a quiet hiss, which is the thermal noise generated by bouncing electrons in the transistor junctions. The lower the noise floor and the higher the headroom, the more usable dynamic range a system has.

pan, pan pot

Short for panoramic potentiometer. A pan pot is used to position (or even move back and forth) a monaural sound source in a stereo mixing field by adjusting the source's volume between the left and right channels. Our brains sense stereo position by hearing this difference in loudness when the sound strikes each ear, taking into account time delay, spectrum, ambient reverberation and other cues.

parametric EQ

A "fully" parametric EQ is an extremely powerful equalizer that allows smooth, continuous control of each of the three primary EQ parameters (frequency, gain, and bandwidth) in each section independently. "Semi" parametric EQs allow control of fewer parameters, usually frequency and gain (i.e., they have a fixed bandwidth, but variable center frequency and gain).

peaking

The opposite of dipping, of course. A peak is an EQ curve that looks like a hill, or a peak. Peaking with an equalizer amplifies a band of frequencies.

PFL

An acronym for Pre Fade Listen. Broadcasters would call it cueing. Sound folks call it being able to solo a channel with the fader down.

phantom power

A system of providing electrical power for condenser microphones (and some electronic pickup devices) from the sound mixer. The system is called phantom because the power is carried on standard microphone audio wiring in a way that is "invisible" to ordinary dynamic microphones. Mackie mixers use standard +48 volt DC power, switchable on or off. Most quality condenser microphones are designed to use +48 VDC phantom power. Check the manufacturer's recommendations.

Generally, phantom power is safe to use with non-condenser microphones as well, especially dynamic microphones. However, unbalanced microphones, some electronic equipment (such as some wireless microphone receivers) and some ribbon microphones can short out the phantom power and be severely damaged. Check the manufacturer's recommendations and be careful!

phasing

A delay effect, where the original signal is mixed with a short (0 to 10 msec) delay. The

time of the delay is slowly varied, and the combination of the two signals results in a dramatic moving comb-filter effect. Phasing is sometimes imitated by sweeping a comb-filter EQ across a signal. A comb filter can be found in your back pocket.

phone jack

Ever see those old telephone switchboards with hundreds of jacks and patch cords and plugs? Those are phone jacks and plugs, now used widely with musical instruments and audio equipment. A phone jack is the female connector, and we use them in 1/4" two-conductor (TS) and three-conductor (TRS) versions.

phone plug

The male counterpart to the phone jack, right above.

phono jack

See *RCA phono jack*.

phono plug

See *RCA phono plug*.

post-fader

A term used to describe an aux send (usually) that is connected so that it is affected by the setting of the associated channel fader. Sends connected this way are typically (but not always) used for effects. See *pre-fader*.

pot, potentiometer

In electronics, a variable resistor that varies the potential, or voltage. In audio, any rotary or slide control.

pre-fader

A term used to describe an aux send (usually) that is connected so that it is not affected by the setting of the associated channel fader. Sends connected this way are typically (but not always) used for monitors (foldback). See *post-fader*.

proximity effect

The property of many directional microphones to accentuate their bass response when the source-to-mic distance is small, typically three inches or less. Singers generally like this effect even more than singing in the shower.

Q

A way of stating the bandwidth of a filter or equalizer section. An EQ with a Q of .75 is broad and smooth, while a Q of 10 gives a narrow, pointed response curve. To calculate the value of Q, you must know the center frequency of the EQ section and the frequencies at which the upper and lower skirts fall 3dB below the level of the center frequency. Q

equals the center frequency divided by the difference between the upper and lower -3dB frequencies. A peaking EQ centered at 10kHz whose -3dB points are 7.5kHz and 12.5kHz has a Q of 2.

RCA phono jack—or RCA jack or phono jack

An RCA phono jack is an inexpensive connector (female) introduced by RCA and originally used to connect phonographs to radio receivers and phono preamplifiers. The phono jack was (and still is) widely used on consumer stereo equipment and video equipment but was quietly fading into obscurity in the professional and semi-professional sound world. Then phono jacks began cropping up in early project-studio multitrack recorders, which (unfortunately) gave them a new lease on life. Since so many stereo recorders are fitted with them, we decided we'd have to put a couple on our mixers for your convenience. But make no mistake: the only thing that the phono jack (or plug) has going for it is low cost.

RCA phono plug

The male counterpart to an RCA phono jack. See above.

regeneration

Also called recirculation. A delay effect created by feeding the output of a delay back into itself to cause a delay of the delay of the delay. You can do it right on the front panel of many effects units, or you can route the delay return back into itself on your mixer. Can be a great deal of fun at parties.

return

A return is a mixer line input dedicated to the task of returning processed or added sound from reverb, echo and other effects devices. Depending on the internal routing of your mixer and your own inclination, you could use returns as additional line inputs, or you could route your reverb outputs to ordinary line inputs rather than the returns.

reverberation, reverb

The sound remaining in a room after the source of sound is stopped. It's what you hear in a large tiled room immediately after you've clapped your hands. Reverberation and echo are terms that can be used interchangeably, but in audio parlance a distinction is usually made: reverberation is considered to be a diffuse, continuously smooth decay of sound, whereas echo is a distinct, recognizable repetition of a word, note, phrase or sound. Reverberation and echo can be added in sound

mixing by sending the original sound to an electronic (or electronic/acoustic) system that mimics natural reverberation, or worse. The added reverb is returned to the blend through additional mixer inputs. Highly reverberant rooms are called live; rooms with very little reverberation are called dead. A sound source without added reverb is dry; one with reverb or echo added is wet.

RMS

An acronym for root mean square, a conventional way to measure AC voltage and audio signal voltage. Most AC voltmeters are calibrated to read RMS volts. Other conventions include average volts, peak volts and peak-to-peak volts.

send

A term used to describe a secondary mix and output of the input signals, typically used for foldback monitors, headphone monitors or effects devices. Mackie mixers call it an Aux Send.

shelving

A term used to describe the shape of an equalizer's frequency response. A shelving equalizer's response begins to rise (or fall) at some frequency and continues to fall (or rise) until it reaches the shelf frequency, at which point the response curve flattens out and remains flat to the limits of audibility. If you were to graph the response, it would look like a shelf. Or more like a shelf than a hiking boot. The EQ controls on your stereo are usually shelving equalizers. See also *peaking* and *dipping*.

slap, slapback

A single-delay echo without any repeats. Also see *echo*.

solo

Italian for alone. In audio mixers, a solo circuit allows the engineer to listen to individual channels, buses or other circuits singly or in combination with other soloed signals.

SR

An acronym for Sound Reinforcement, which refers to a system of amplifying acoustic and electronic sounds from a performance or speech so that a large audience can hear clearly. Or, in popular music, so that a large audience can be excited, stunned or even partially deafened by the tremendous amplification. Means essentially the same thing as PA (Public Address).

stereo

Believe it or not, stereo comes from a Greek word that means solid. We use stereo or stereophony to describe the illusion of a continuous, spacious soundfield that is seemingly spread around the listener by two or more related audio signals. In practice, stereo often is taken to simply mean two channels.

sweep EQ

An equalizer that allows you to “sweep” or continuously vary the frequency of one or more sections.

symmetrically balanced

See *balanced*.

tinnitus

The ringing in the ears that is produced with prolonged exposure to high volumes. A sound in the ears, such as buzzing, ringing, or whistling, caused by volume knob abuse!

trim

In audio mixers, the gain adjustment for the first amplification stage of the mixer. The trim control helps the mixer cope with the widely varying range of input signals that come from real-world sources. It is important to set the trim control correctly; its setting determines the overall noise performance in that channel of the mixer. See *mic preamp*.

TRS

Acronym for Tip-Ring-Sleeve, a scheme for connecting three conductors through a single plug or jack. ¼" phone plugs and jacks and ⅛" mini phone plugs and jacks are commonly wired TRS. Since the plug or jack can carry two signals and a common ground, TRS connectors are often referred to as stereo or balanced plugs or jacks. Another common TRS application is for insert jacks, used for inserting an external processor into the signal path. In Mackie mixers, the tip is send, ring is return, and sleeve is ground.

TS

Acronym for Tip-Sleeve, a scheme for connecting two conductors through a single plug or jack. ¼" phone plugs and jacks and ⅛" mini phone plugs and jacks are commonly wired TS. Sometimes called mono or unbalanced plugs or jacks. A ¼" TS phone plug or jack is also called a standard phone plug or jack.

unbalanced

An electrical circuit in which the two legs of the circuit are not balanced with respect to ground. Usually, one leg will be held at ground potential. Unbalanced circuit connections require only two conductors (signal “hot” and ground). Unbalanced audio circuitry is less

expensive to build, but under certain circumstances is more susceptible to noise pickup.

unity gain

A circuit or system that has its voltage gain adjusted to be one, or unity. A signal will leave a unity gain circuit at the same level at which it entered. In Mackie mixers, unity gain is achieved by setting all variable controls to the marked “U” setting. Mackie mixers are optimized for best headroom and noise figures at unity gain.

VLZ

Acronym for very low impedance.

(Impedance is measured in ohms represented by the Ω symbol, which is the last letter of the Greek alphabet. This is why the letter Z is used instead of I.) VLZ is one of the most important reasons why inherent noise levels on Mackie mixing boards are so minuscule. Thermal noise is something that’s created by all circuitry and usually transistors and resistors are the worst culprits. The basic rule with thermal noise is: the higher the impedance, the more the noise. Mackie’s VLZ design reduces thermal noise by making internal impedances as low as possible in as many places as possible within the console. VLZ is achieved by scaling down resistor values by a factor of three or four – resulting in a corresponding reduction in thermal noise. This is especially true for the console’s mixing buses.

volume

Electrical or sound level in an audio system. Perhaps the only thing that some bands have too much of.

VRMS

See *RMS*.

wet

With added reverberation or other effect like echo, delay or chorusing.

XLR connector

See *Cannon*.

APPENDIX B: CONNECTIONS

“XLR” CONNECTORS

Mackie mixers use 3-pin female “XLR” connectors on all microphone inputs, with pin 1 wired to the grounded (earthed) shield, pin 2 wired to the “high” (“hot” or positive polarity) side of the audio signal and pin 3 wired to the “low” (“cold” or negative polarity) side of the signal (Figure A). All totally aboveboard and in full accord with the hallowed standards dictated by the AES (Audio Engineering Society).

Use a male “XLR”-type connector, usually found on the nether end of what is called a “mic cable,” to connect to a female XLR jack.

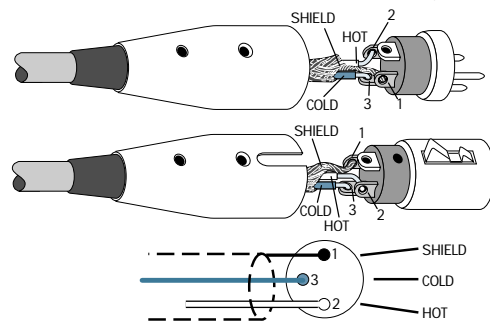

Figure A: XLR Connectors

1/4" TRS PHONE PLUGS AND JACKS

“TRS” stands for Tip-Ring-Sleeve, the three connections available on a “stereo” 1/4" or “balanced” phone jack or plug. See Figure B. TRS jacks and plugs are used in several different applications:

- Stereo Headphones, and rarely, stereo microphones and stereo line connections. When wired for stereo, a 1/4" TRS jack or plug is connected tip to left, ring to right and

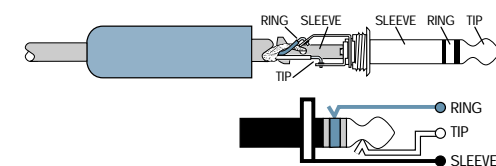

Figure B: 1/4" TRS Plugs

sleeve to ground (earth). Mackie mixers do not directly accept 1-plug-type stereo microphones. They must be separated into a left cord and a right cord, which are plugged into the two mic preamps.

You can cook up your own adapter for a stereo microphone adapter. “Y” two cables out of a female 1/4" TRS jack to two male XLR plugs, one for the Right signal and one for the Left.

- Balanced mono circuits. When wired as a balanced connector, a 1/4" TRS jack or plug is connected tip to signal high (hot), ring to signal low (cold), and sleeve to ground (earth).
- Unbalanced Send/Return circuits. When wired as send/return “Y” connector, a 1/4" TRS jack or plug is connected tip to signal send (output from mixer), ring to signal return (input back into mixer), and sleeve to ground (earth).

1/4" TS PHONE PLUGS AND JACKS

“TS” stands for Tip-Sleeve, the two connections available on a “mono” 1/4" phone jack or plug (Figure C). TS jacks and plugs are used in many different applications, always unbalanced. The tip is connected to the audio signal and the sleeve to ground (earth). Some examples:

- Unbalanced microphones
- Electric guitars and electronic instruments
- Unbalanced line-level connections

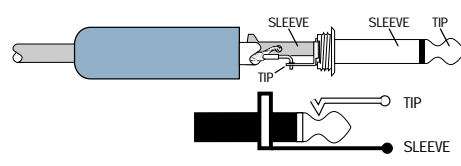

Figure C: TS Plug

SWITCHED 1/4" PHONE JACKS

Switches can be incorporated into 1/4" phone jacks, which are activated by inserting the plug. These switches may open an insert loop in a circuit, change the input routing of the signal or serve other functions. Mackie uses switches in the channel insert and bus insert jacks, input jacks and AUX returns. We also use these switches to ground the line-level inputs when nothing is plugged into them.

In most cases, the plug must be inserted fully to activate the switch. Mackie takes advantage of this in some circuits, specifying circumstances where you are to insert the plug only partially. See **Special Mackie Connections**, later in this section.

RCA PLUGS AND JACKS

RCA-type plugs (also known as phono plugs) and jacks are often used in home stereo and video equipment and in many other applications (Figure D). They are unbalanced and electrically identical to a 1/4" TS phone plug or jack (See Figure C). Connect the signal to the center post and the ground (earth) or shield to the surrounding "basket."

UNBALANCING A LINE

In most studio, stage and sound reinforcement situations, there is a combination of balanced and unbalanced inputs and outputs on the various pieces of equipment. This usually will not be a problem in making connections.

- When connecting a balanced output to an unbalanced input, be sure the signal high (hot) connections are wired to each other, and that the balanced signal low (cold)

goes to the ground (earth) connection at the unbalanced input. In most cases, the balanced ground (earth) will also be connected to the ground (earth) at the unbalanced input. If there are ground-loop problems, this connection may be left disconnected at the balanced end.

- When connecting an unbalanced output to a balanced input, be sure that the signal high (hot) connections are wired to each other. The unbalanced ground (earth) connection should be wired to the low (cold) and the ground (earth) connections of the balanced input. If there are ground-loop problems, try connecting the unbalanced ground (earth) connection only to the input low (cold) connection, and leaving the input ground (earth) connection disconnected.

In some cases, you will have to make up special adapters to interconnect your equipment. For example, you may need a balanced XLR female connected to an unbalanced 1/4" TS phone plug.

SPECIAL MACKIE CONNECTIONS

The balanced-to-unbalanced connection has been anticipated in the wiring of Mackie jacks. A 1/4" TS plug inserted into a 1/4" TRS balanced

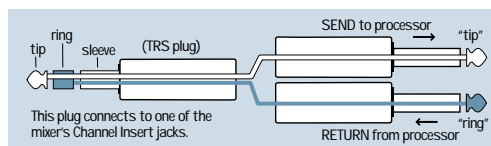

Figure F

input, for example, will automatically unbalance the input and make all the right connections. Conversely, a 1/4" TRS plug inserted into a 1/4" unbalanced input will automatically tie the ring (low or cold) to ground (earth).

TRS Send/Receive Insert Jacks

Mackie's single-jack inserts are the three-conductor, TRS-type 1/4" phone. They are unbalanced, but have both the mixer output (send) and the mixer input (return) signals in one connector (See Figure F).

The sleeve is the common ground (earth) for both signals. The send from the mixer to the external unit is carried on the tip, and the return from the unit to the mixer is on the ring.

Using the Send Only on an Insert Jack

If you insert a TS (mono) 1/4" plug only partially (to the first click) into a Mackie insert jack, the plug will not activate the jack switch and will not open the insert loop in the circuit (thereby allowing the channel signal to continue on its merry way through the mixer).

This allows you to tap out the channel or bus signal at that point in the circuit without interrupting normal operation.

If you push the 1/4" TS plug in to the second click, you will open the jack switch and create a direct out, which does interrupt the signal in that channel. See Figure E.



NOTE: Do not overload or short-circuit the signal you are tapping from the mixer. That will affect the internal signal.

MACKIE STEREO INPUTS AND RETURNS: Mono, Stereo, Whatever

Stereo line inputs and stereo AUX returns are a fine example of the Mackie philosophy (which we just made up) of Maximum Flexibility with Minimum Headache. The inputs and returns will automatically be mono or stereo, depending upon how you use the jacks. Here's how it works:

A mono signal should be patched into the input or return jack labeled Left (MONO). The signal will be routed to both the left and right sides of the return circuit, and will show up in the center of the stereo pair of buses it's assigned to, or it can be "panned" with the Balance control.

A stereo signal, having two plugs, should be patched into the LEFT (MONO) and the RIGHT input or return jacks. A jack switch in the RIGHT jack will disable the mono function, and the signals will show up in stereo.

A mono signal connected to the RIGHT jack will show up in the right bus only. You probably will only want to use this sophisticated effect for special occasions (weddings, bar mitzvahs, Rush Limbaugh's birthday party, etc.)

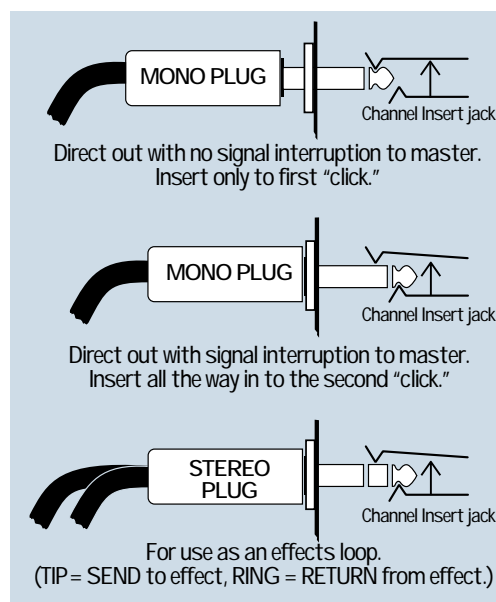

Figure E

MULTS AND “Y”s

A mult or “Y” connector allows you to route one output to two or more inputs by simply providing parallel wiring connections. You can make “Y”s and mults for the outputs of both unbalanced and balanced circuits.



Remember: Only mult or “Y” an output into several inputs. If you need to combine several outputs into one input, you must use a mixer; not a mult or a “Y.”

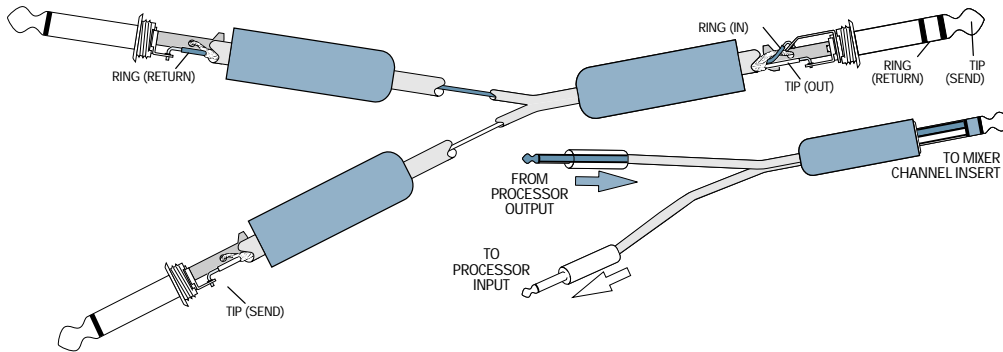

Y-cord insert cable

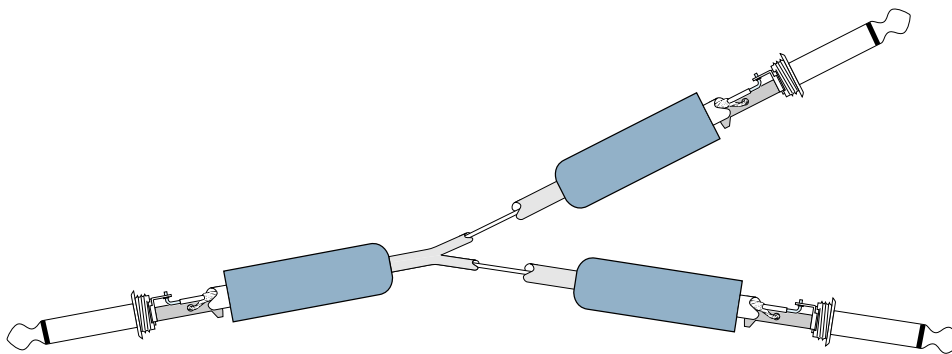

Y-cord splitter cable

APPENDIX C: BALANCED LINES, PHANTOM POWERING, GROUNDING AND OTHER ARCAINE MYSTERIES

Balanced Lines

Balanced lines offer increased immunity to external noise (specifically, hum and buzz). Because a balanced system is able to minimize noise, it is the preferred interconnect method, especially in cases where very long lengths of cable are being used. A long unbalanced cable carries with it more opportunity for noise to get into a system — having balanced inputs means very little noise will enter the system via snakes and other cables that typically must run a long length. But regardless of length, balanced lines are best.

Phantom Powering and Microphones

History

Condenser (capacitor) microphones differ from dynamic and ribbon microphones because they are not self-generating. That is, they cannot generate electricity in response to an impinging sound wave. A condenser microphone modifies an external source of electricity to reflect the effects of a sound wave striking its diaphragm.

Dynamic and ribbon microphones use magnetism to generate electricity in response to a sound wave: they are self-generating. Furthermore, both of these types of microphones are inherently low-impedance devices. It is possible to connect a dynamic microphone element directly to a balanced, low-impedance mixer input. Many commercially made dynamic microphones do just that.

On the other hand, a condenser microphone is an inherently high-impedance device. How high? Verrrrrry high. On the order of a billion ohms (1 Gigaohm). This is high enough that the inherent capacitance of a foot of shielded cable would audibly reduce the output of the microphone. All condenser microphones have an impedance converter, in the form of a vacuum tube or field-effect transistor (FET), built into the microphone and located extremely close to the microphone element. The impedance converter and the microphone element itself require an external power source.¹

¹ To be strictly correct, electret condenser microphones are a bit different, as the microphone element does not require a power source for operation (it is more or less permanently self-polarized). Regardless, the impedance converter still requires an external source of power.

What is it, exactly?

The obvious external power source for any modern microphone is a battery. About the only electronic advantage that a battery has is that its output is pure DC. The only other advantage is to the battery company — you have to keep on buying them.

Tube microphones require several different voltages for operation. This invariably means a multi-conductor cable and non-standard (not XLR) connectors. A tube microphone will always have an associated external power supply.

In the late 1960's, Neumann (you know, the folks that brought you the U47 and U87 microphones) converted its microphones to solid-state, adopting a system of remote powering that they called, and trademarked, Phantom Powering. Because of the trademark, some manufacturers use terms like Simplex Powering, etc. Over the years, the trademark has become genericized and now refers to any device that is powered according to DIN standard 45 596 (or maybe it's DIN standard 45 595, we're not exactly sure...).

So, why "Phantom" Powering? Because (like the Phantom in the old comic strip) it's there when you need it, and invisible when you don't. This technology is not new; it actually predates rocket science. Like many other things in audio, it was brought to you by the telephone company, who used it to get an extra circuit from a pair of wires. In effect, so does your phantom powered microphone.

What is important is: phantom powering is a compatible system. Your dynamic/ribbon microphones as well as your condenser microphones work side-by-side, from the same microphone inputs, without further thought on your part.

Technically speaking, phantom powering refers to a system where the audio signal is applied to the balanced line in differential-mode, and

PHANTOM POWER DO & DON'T CHART	
DO	DON'T
If you are plugging in a condenser microphone, do verify that your microphone can be phantom powered.	Worry about your other microphones as long as their output is balanced and floating.
Ensure that the microphone's output is low impedance, balanced and floating. This is especially important for vintage ribbon microphones like the RCA 44BX and 77DX.	Connect microphones or devices that do not conform to the DIN 45 596 standard.
Mute the sound system when turning the phantom power on or off, or when connecting or disconnecting microphones. If you forget, the resulting loud, nasty POP may be your last.	Don't connect A-B or T-system microphones (another remote powering system) without suitable adaptors.

the DC power is applied common-mode. The audio travels via pins 2 and 3, the power travels between pins 2 and 3 simultaneously, and pin 1 is the ground for both audio and power.

Microphones that do not require power simply ignore the DC present between pin 2/pin 3 and pin 1. If you measure with a voltmeter between pin 2 and pin 3, you will read 0 Volts DC. This is what your dynamic microphone sees. Measuring between pin 2 and pin 1, or between pin 3 and pin 1, you will read the phantom power voltage, usually 48V, without a microphone connected. The dynamic microphone, as well as your balanced mixer input, ignores this voltage.

Lately, the term phantom power has been perverted to refer to any remote powering system. In the strict sense of the DIN standard, this is not true. Furthermore, microphones or transducers that claim to use this system are not compatible with the DIN standard and will almost certainly be damaged if connected into such a system. Fortunately, these systems use tip-ring-sleeve phone plugs or miniature XLR connectors and they are usually associated with instrument pickup applications².

Phantom powering is defined in DIN standard 45 596 or IEC standard 268-15A. Your Mackie Designs mixer conforms to this standard.

² There is another remote powering system called A-B or T-system powering. It uses pins 2 and 3 to carry both power and audio. It is not compatible with dynamic microphones or phantom-powered microphones.

What works?

To be compatible in a phantom powered system, a device (microphone, preamp with a microphone-style output, or direct box) must have a balanced and floating, low-impedance output. This includes all microphones commonly used for sound reinforcement and recording, such as the Shure® SM58, SM57, Electro-Voice® RE-15, RE-16, RE-20, ND series, Beyer® M160, M500, AKG® D224, D12, D112, and *many* others.

If you are fortunate enough to own any tube condenser microphones, such as the AKG® C12, Neumann® U47 or U67, these microphones may be connected in a phantom powered system and will operate without regard to the presence or absence of phantom power. They will always require their external power supply (which must be plugged in and turned on).

What doesn't work?

The list is short:

1. Microphones with unbalanced outputs.
2. Microphones with grounded center-tapped outputs. Many old ribbon microphones were supplied connected this way. Have a technician lift the ground from the center tap.
3. High-impedance microphones.
4. Microphones that exhibit leakage between pin 2 or pin 3 and pin 1. These microphones will sputter and crackle when phantom power is applied and will work fine when you turn off the phantom power. Get the microphone repaired.

Do's and Don'ts of Fixed Installations

If you install sound systems into fixed installations, there are a number of things that you can do to make your life easier and that increase the likelihood of the sound system operating in a predictable manner. Even if you don't do fixed installations, these are good practices for any sound system, installed.

1. Do use foil-shielded snake cable for long cable runs. Carefully terminate each end, minimizing the amount of shielding removed. Protect the exposed foil shield with shrink sleeving or PVC sleeving. Prevent adjacent shields from contacting each other (electrically). Use insulating sleeving on the drain wire (the one that connects to pin 1) to prevent it from contacting the connector shell.
2. Don't connect the XLR connector shell to pin 1 of the XLR connector (unless necessary for RFI shielding). Doing so is an invitation for a ground loop to come visiting.
3. Do ensure that your speaker lines and AC power lines are physically separated from your microphone lines.
4. If you use floor pockets, use separate pockets for inputs and speakers, or put the connectors on opposite sides of the box so that they may be shielded separately.
5. If your speaker lines run in the open, they should be twisted pairs, at least 6 twists per foot. Otherwise, run the speaker lines in their own conduit. (Of course, conduit is not too practical for portable systems, heh-heh.)
6. Minimize the distance between the power amplifiers and the speakers.
7. Use heavy gauge, stranded wire for speaker lines. Ideally, the wire resistance should be less than 6% (0.5dB power loss) of the load impedance. Remember that the actual run is twice as long as the physical length of the run. See below.
8. Ensure that the electrician uses the star-ground system for the safety grounds in your electrical system. All of the audio system grounds should terminate at the same physical point. No other grounds may come in contact with this ground system.
9. Ensure that the AC power feeds are connected to the same transformer, and ideally, the same circuit breaker.
10. Walk outside – look at the horizon, see any radio towers? Locate potential sources of RF interference and plan for them before you begin construction. Know the frequency, transmitter power, etc. You can get this information by calling the station. Remember that many broadcast stations change antenna coverage pattern and transmitter power at night.
11. Don't use hardware-store light dimmers.
12. Don't allow for anything other than microphone inputs at stage/altar locations. Supplying line inputs at these locations is an invitation for misuse. Make all sources look like microphones to the console.
13. Balance (or at least impedance balance) all connections that are remote from the console's immediate location.
14. If you bridge an amplifier, don't use ¼" phone plugs for speaker connectors.

Grounding

Grounding exists in your audio system for two reasons: product safety and noise reduction. The third wire on the power cord exists for product safety. It provides a low-resistance path back to the electrical service to protect the users of the product from electrical shock. Hopefully, the resistance to ground through the safety ground (third wire) is lower than that through the user/operator to ground. If you remove this connection (by breaking or cutting the pin off, or by using a 'ground cheater'), this alternate ground path ceases to exist, which is a safety hazard.

The metal chassis of the product, the ground connections provided by the various connectors, and the shields within your connecting cables provide a low potential point for noise signals. The goal is to provide a lower impedance path to ground for noise signals than through the signal wiring. Doing so helps minimize hum, buzz, and other extraneous non-audio signals.

Maximum wire run for 0.5dB power loss in feet

wire gauge	res. per 1000 ft.	2 Ω	4 Ω	8 Ω
10	1.00	60	120	240
12	1.59	40	75	150
14	2.5	24	48	95
16	4.02	15	30	60

Many “authorities” tell you that shields should only be connected at one end. Sometimes this can be true, but for most (99%) audio systems, it is unnecessary. If you do everything else correctly, you should be able to connect every component of your audio system using standard, off-the-shelf connecting cables that are available at any music store.

Here are some guidelines:

1. All return lines to the stage should be balanced. At a minimum, they should be impedance balanced. Remember that you can balance a line by inserting a piece of equipment inline that has a balanced output.
2. Run your own AC power wiring from the stage for the mixer and related equipment. Don't use the “conveniently located” receptacle thoughtfully provided by the management for your use. You have no idea how it's wired or grounded.
3. Carry an outlet tester, available at any well-stocked hardware store. Use it to tell you if the outlet you're about to plug into is wired correctly. Consider it cheap insurance.
4. If you carry enough equipment that you need to wire directly into the electrical service, then use a voltmeter to ensure that the line voltage is correct, then use the outlet tester mentioned in #3, above. Do this before you connect any of your audio equipment. Chances are that your 120V gear won't be too happy if it sees 220V for any length of time.
5. Cables that are too long are less likely to pick up hum if you uncoil them in their entirety, and then find a place to stow the excess. Leaving the excess coiled only helps the cable pick up hum more efficiently.
6. Don't run unbalanced lines to or from the stage. It's not the impedance, it's the fact that they're unbalanced. It's a good idea to use a direct box to make the unbalanced source look like a microphone.
7. For really extreme cases, you may need to insert 1:1 or isolation transformers into each return line from the front-of-house location to your amp racks.
8. Don't cut the third pin off of the power cord. Carry some ground-lifter adapters and use them only when you have to plug into an ancient two-wire outlet.
9. If you bundle your cables together, don't bundle AC wiring and audio wiring together. Bundle them separately.
10. If your sound system insists on humming, you may need to teach it the words.

FREE T-SHIRT OFFER

We love to hear what folks have created using our mixers. If you use your 1604-VLZ PRO to track and/or mix a CD that is commercially released, we'll trade you a disc for a genuine Mackie T-Shirt! By “commercially released,” we mean “offered for sale,” even if it's just being sold out the back door of a local Karaoke joint. No hand-lettered covers, please and thank you. Furthermore, if you send us an interesting story or photograph about your production we might use it! To get your genuine 100% cotton Mackie T-shirt, send your CD (and optional story or photo) to:

Mackie Designs
FREE T-SHIRT OFFER
attn: Communications Department
16220 Wood-Red Rd. NE
Woodinville, WA 98072

(Roll credits please) Manual written by Jeff Gilbert, based on a vignette by Ron Koliha, with tidbits borrowed from almost everywhere. Manual then defaced with proofreading pens in the hands of Mackie's legendary Tech Support staff. Manual composed on a rinky-dink PC using a low-budget word processor, then converted to this amazing piece of work using a 13-story 1000 gigawhopper Macintosh operated by Mackie's notorious Advertising staff. Please, feel free to let us know if you find an error or stumble over a confusing paragraph. Thank you for reading the entire manual (we know you have, or you wouldn't be here).

Mackie Designs is always striving to improve our mixers by incorporating new and improved materials, components and manufacturing methods. Because we're always trying to make things better, we reserve the right to change these specifications at any time, without notice.

Mackie, the “Running Man” figure, VLZ and XDR are trademarks or registered trademarks of Mackie Designs Inc. All other brand names mentioned are trademarks or registered trademarks of their respective holders, and are hereby acknowledged.

MACKIE.

1604-VLZ PRO

16-CHANNEL MIC/LINE MIXER
WITH PREMIUM XDR™ MIC PREAMPLIFIERS

Session: _____

Date: _____

NOTES: _____

TRIM	1	TRIM	2	TRIM	3	TRIM	4	TRIM	5	TRIM	6	TRIM	7	TRIM	8
10dBV U-MIC GAIN		10dBV U-MIC GAIN		10dBV U-MIC GAIN		10dBV U-MIC GAIN		10dBV U-MIC GAIN		10dBV U-MIC GAIN		10dBV U-MIC GAIN		10dBV U-MIC GAIN	
AUX		AUX		AUX		AUX		AUX		AUX		AUX		AUX	
PRE	<input type="checkbox"/>	PRE	<input type="checkbox"/>	PRE	<input type="checkbox"/>	PRE	<input type="checkbox"/>	PRE	<input type="checkbox"/>	PRE	<input type="checkbox"/>	PRE	<input type="checkbox"/>	PRE	<input type="checkbox"/>
S/6 SHIFT	<input type="checkbox"/>	S/6 SHIFT	<input type="checkbox"/>	S/6 SHIFT	<input type="checkbox"/>	S/6 SHIFT	<input type="checkbox"/>	S/6 SHIFT	<input type="checkbox"/>	S/6 SHIFT	<input type="checkbox"/>	S/6 SHIFT	<input type="checkbox"/>	S/6 SHIFT	<input type="checkbox"/>
EQ		EQ		EQ		EQ		EQ		EQ		EQ		EQ	
PAN		PAN		PAN		PAN		PAN		PAN		PAN		PAN	
MUTE	<input type="checkbox"/>	MUTE	<input type="checkbox"/>	MUTE	<input type="checkbox"/>	MUTE	<input type="checkbox"/>	MUTE	<input type="checkbox"/>	MUTE	<input type="checkbox"/>	MUTE	<input type="checkbox"/>	MUTE	<input type="checkbox"/>
SOLO	<input type="checkbox"/>	SOLO	<input type="checkbox"/>	SOLO	<input type="checkbox"/>	SOLO	<input type="checkbox"/>	SOLO	<input type="checkbox"/>	SOLO	<input type="checkbox"/>	SOLO	<input type="checkbox"/>	SOLO	<input type="checkbox"/>
L-R		L-R		L-R		L-R		L-R		L-R		L-R		L-R	



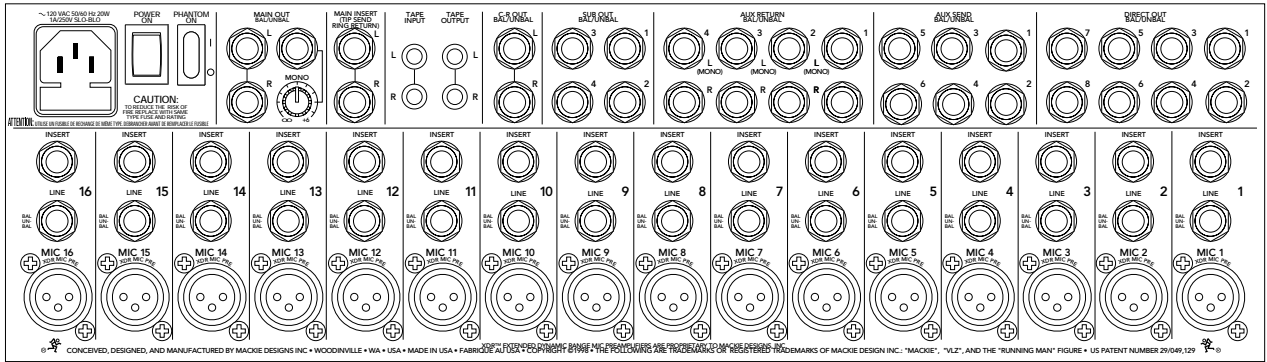

MACKIE®

1604-VLZ PRO

16-CHANNEL MIC/LINE MIXER
WITH PREMIUM XDR™ MIC PREAMPLIFIERS

TRIM 9 10dBV U MIC GAIN (+15dB -45dB)

AUX 1 U COO +15

EQ U HI 12k MID 15k LOW 800 Hz

PAN L R

9 MUTE

TRACK 1

TRIM 10 10dBV U MIC GAIN (+15dB -45dB)

AUX 2 U COO +15

EQ U HI 12k MID 15k LOW 800 Hz

PAN L R

10 MUTE

TRACK 2

TRIM 11 10dBV U MIC GAIN (+15dB -45dB)

AUX 3 U COO +15

EQ U HI 12k MID 15k LOW 800 Hz

PAN L R

11 MUTE

TRACK 3

TRIM 12 10dBV U MIC GAIN (+15dB -45dB)

AUX 4 U COO +15

EQ U HI 12k MID 15k LOW 800 Hz

PAN L R

12 MUTE

TRACK 4

TRIM 13 10dBV U MIC GAIN (+15dB -45dB)

AUX 5 U COO +15

EQ U HI 12k MID 15k LOW 800 Hz

PAN L R

13 MUTE

TRACK 5

TRIM 14 10dBV U MIC GAIN (+15dB -45dB)

AUX 6 U COO +15

EQ U HI 12k MID 15k LOW 800 Hz

PAN L R

14 MUTE

TRACK 6

TRIM 15 10dBV U MIC GAIN (+15dB -45dB)

AUX 7 U COO +15

EQ U HI 12k MID 15k LOW 800 Hz

PAN L R

15 MUTE

TRACK 7

TRIM 16 10dBV U MIC GAIN (+15dB -45dB)

AUX 8 U COO +15

EQ U HI 12k MID 15k LOW 800 Hz

PAN L R

16 MUTE

TRACK 8

LAMP 12V 0.5A

AUX SEND TO AUX SEND 1 TO AUX SEND 2

ASSIGN OPTIONS

STEREO AUX RETURN

LEVEL SET 0dB=0dBu

ASSIGN TO MAIN MIX

PHONES MAIN MIX